

EXI-200AD

Explosion proof Indicator

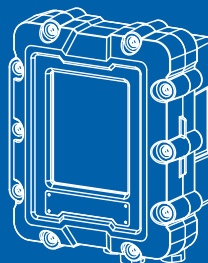

www.globalcas.com

OWNER'S MANUAL

CAS

Contents

Cautions for Safety	6
1. Normal Requirements	9
1.1 Application Range.....	9
1.2 Transport, assembly and installation.....	9
1.3 Function, Operation and Use.....	13
1.4 Maintenance and Cautions.....	15
2. Technical Specifications	16
2.1 Product Specifications	16
2.2 Product Labelling	16
2.3 Product Structure and Composition	17
2.4 Handling Cautions	17
3. Features	18
3.1 Features.....	18
3.2 Main Functions.....	18
3.3 Product Specifications	19
4. External Explanation	21
4.1 External Specifications	21
4.2 Frontal Surface Explanation.....	22
4.3 Display Explanantion	24
4.4 Key manual	25
5. Internal Explanation	27
5.1 Internal Explanation.....	27
5.1.1 Power Connector (AC, DC)	28
5.1.2 Load Cell Connector.....	30
5.1.3 RS-232, RS-422/485 Connector.....	32
5.1.4 Relay Input(Optional).....	34

6. Weight Calibration Mode	35
6.1 What is weight calibration?.....	35
6.2 How to enter the weight calibration mode.....	35
6.3 Weight calibration menu (CAL1 – CAL9).....	36
7. Weighing Mode	45
7.1 Zero-set Function.....	45
7.2 Tare function.....	46
7.3 Item number changing.....	46
7.4 Set Point changing.....	47
7.5 Subtotal Print.....	47
7.6 Total Print.....	48
8. Test Mode	49
8.1 Key Test.....	50
8.2 Display Test.....	50
8.3 AD Test.....	51
8.4 Communication Test.....	51
8.5 External Input/output Test_OPTION.....	51
8.6 A-OUT Test_OPTION.....	52
8.7 1/10 division Test.....	52
8.8 EEPROM Test.....	52
8.9 RTC Test_OPTION.....	52
9. Set Mode	53
9.1 How to enter set mode.....	53
9.2 General Function.....	56
9.3 Communication Setting.....	62
9.4 Analogue Output Setting.....	67

9.5 Hardware Set Function	69
9.6 Relay Setting	70
9.7 TCP IP	76
9.8 Print Function Setting	79
10. Error Message.....	84
10.1 Errors that can occur in weight calibration mode	84
10.2 Errors that can occur in weighing mode	85
Appendix 1> Data format	86
Appendix 2> Command Mode 1 Description	88
Appendix 3> Command Mode 2 Description	89
Appendix 4> Command mode 3 Description	90
Appendix 5> ASCII Table.....	90
Appendix 6> MODBUS-RTU PROTOCOL.....	91

Cautions for Your Safety

'Please comply with 'Cautions for Your Safety', which will lead you to use the product safely and properly to prevent any dangerous situations.

- Cautions are divided into 'Warning' and 'Alert', which mean as follows.
- Keep this manual in a place where product users can find out, after finish reading it.



Warning

'Warning' means a great possibility led to the death or heavy injury when instructions are violated.



Attention

'Alert' means a great possibility led to the injury or material damage when instructions are violated.

! Warning

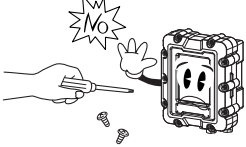
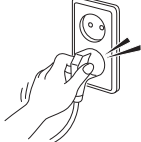
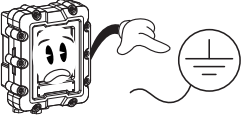
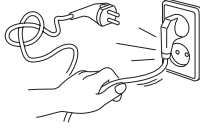
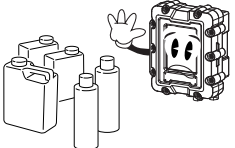
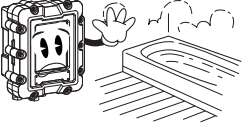
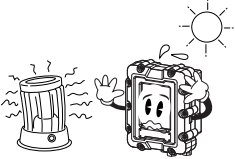
<p>Never disassemble, repair or retrofit the product. It might exclude the product from the quality assurance and cause the damage to devices, electric shock or fire.</p>	<p>Ensure the power plug to be fully inserted to prevent shaking. Any instable connection might cause electric sparks to set fire.</p>	<p>Ensure the grounding of the product. Poor grounding might cause failure or electric shock upon electric leak.</p>
		
<p>Do not damage, process, excessively jerk, bend or twist the power cord. It might damage the power cord to cause fire or electric shock.</p>	<p>Keep any combustible spray or fire source away. It might cause fire.</p>	<p>Do not spray water to the outside of the product or use it in any humid place. It might deteriorate the insulation of electric parts that can cause the electric shock, fire risk or weighing errors.</p>
		
<p>Do not place the product to the direct sunlight or near any hot object like a heater. It might cause fire.</p>		
		

 **Attention**

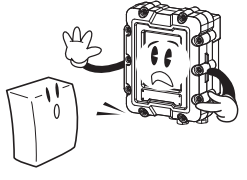
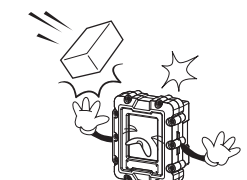
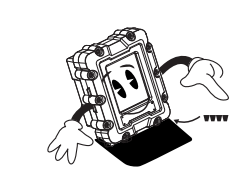
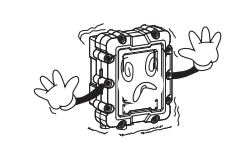
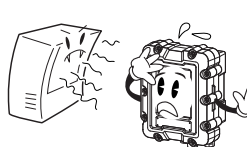
<p>Check the weighing error anytime for the accurate weighing. Any use out of the allowed tolerance for the careless use or other causes might not ensure the accurate weighing.</p>	<p>Avoid any sudden shock to the product. It might damage the product to fail the accurate weighing.</p>	<p>Find a proper place to attach the rubber pad at the bottom of the indicator, which was shipped together.</p>
		
<p>Do not use the product at a place with sudden temperature changes or severe vibrations. It might cause the weighing error or failure.</p>	<p>Do not install the produce at a place with the excessive electromagnetic wave. It might cause the wrong weighing.</p>	
		

1. Normal Requirements

1.1 Application Range

This product is an explosion-proof and dust ignition-proof product for locations of gas, steam or chemical use and other hazardous areas.

■ Explosion-proof Structure and Class

	Explosion proof	Dust ignition proof
Explosion-Proof Class	Ex d IIB +H ₂ T6 IP66	Ex tD A21 85 °C IP66
Gas group	IIB and H ₂ (hydrogen region)	
Temp Class	T6 (85 °C)	

1.2 Transport, assembly and installation

1.2.1. Transport

(1) Packaging method and specification

- (a) After removing any external/internal foreign matter on the product, clean, dry and apply corrosion preventive treatment on exposed sections.
- (b) Measures are needed to prevent foreign matter from entering openings within the product.
- (c) The packaging must correspond with the size and weight of the contents, and internal fillings that can act as a buffer must be used such as air caps or newspapers.
- (d) The product must be appropriately protected to prevent rust and corrosion.

(2) Transport Method

If stacked high during transportation, there is possibility of damage by fall due to the weight of the product. Therefore suitable protective equipment or devices must be used when transporting.

1.2.2. Assembly and Installation

(1) Assembly

This product is fully assembled when shipped and there is no need of separate assembly by the user.

(2) Installation

When installing electrical instruments in an explosion-proof area, compare the below requirements with the technical specifications beforehand to confirm correspondence.

(a) Normal Requirements.

- ① Use installation method (floor installation, wall installation etc.) and installation form (slope allowance etc.) that is appropriate with the explosion prevention electric instrument's usage conditions.
- ② Bolts, nuts, metallic etc. used in the installation must have sufficient mechanical strength. Also, use materials and surface treatment that is clearly based on installation location.
- ③ Ensure recharge sections are not exposed.

(b) Installation Location

- ① Install where it is convenient to operate, manipulate, adjust, maintain etc.
- ② If possible avoid locations exposed to moisture or humidity and avoid high humidity areas.
- ③ If possible avoid areas of corrosive liquid dispersion and near release of corrosive gas.
- ④ Avoid locations close to high temperature heating elements such as heat pipes, steam pipe etc. and areas of rapid temperature fluctuation.
- ⑤ Avoid locations that is heavily affected by vibrations from mechanical devices etc.
- ⑥ Do not install in locations of high pressure or heavy electric noise.
- ⑦ Do not install in location of strong direct sunlight.

(c) Installation method must be suitable to the purpose.

(d) Power connection and wiring.



- ① Use a cable with internal ground wire for the power line and install separately from the signal line.



- ② Connect the power cord with the power socket in an explosion proof area and when connecting in an explosive area always connect using "plugs and receptacles".



- ③ Connect the power and signal lines through a designated location. (Refer to 4.2.2)

(e) Wiring Method during Installation (power and load cell)

- ① Refer to "4. External Explanation" and "5. Internal Explanation" of this manual.
- ② Use an Allen wrench to loosen the front bolts and open the front cover

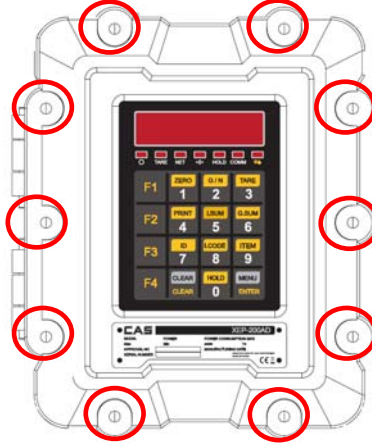

- ③ Connect an appropriate cable gland (joint screw diameter(M20*1.5)) to the power line. (Refer to 4.2 Front Surface Explanation)
- ④ Connect the power line to the power terminal as depicted in the figure below. Refer to this manual's "5.1.1 Power Connector" for the wiring order. (Connect the power line using a 4Φ terminal etc.)

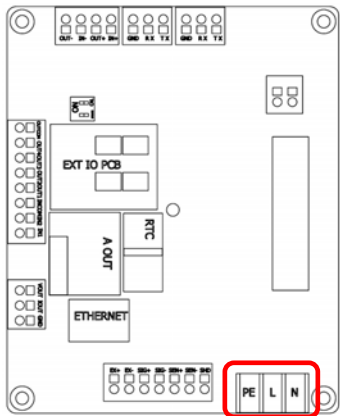

<AC Type>

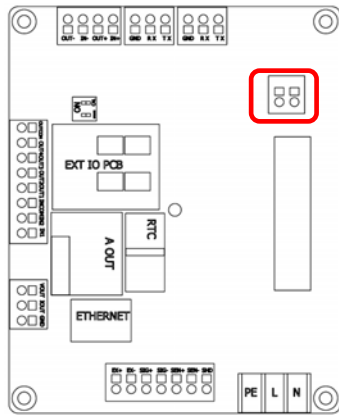

<DC Type>

- ⑤ Connect an appropriate cable gland (joint screw diameter (M20*1.5)) to the load cell line.
(Refer to 4.2 Front Surface Explanation)
- ⑥ Refer to this manual's "5.1.2 Load Cell Connector" and the wiring blueprint of the load cell for the wiring order. (Connect the load cell line using pin terminals etc.)

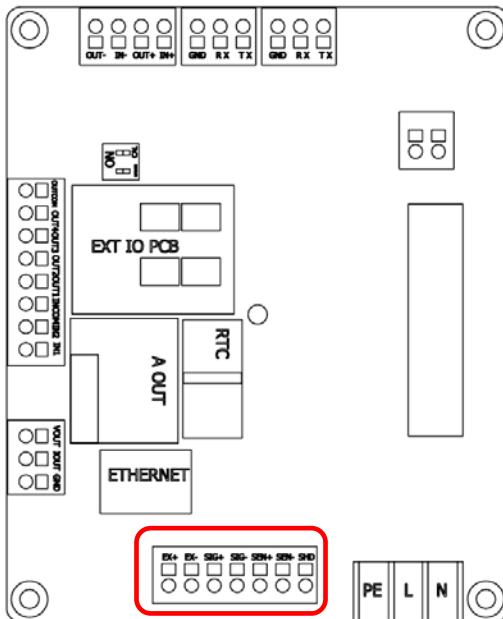

1.3 Function, Operation and Use

1.3.1. Inspection and Adjustment

- (1) For the explosion-proof instrument, check for following suitability list
 - (a) Terminal voltage, pole number
 - (b) The type and specification of replacement parts from each part
 - (c) Whether the overall control system (control, manipulation, display, notification etc) is working
 - (d) Operation and display of auxiliary instruments
 - (e) Presence of vibration and its intensity.
 - (f) Inspection of the wiring inlet.
 - ① Whether metallic wiring material suitable to the conduit tube screw section specifications are used.
 - ② Whether sealing has been installed on conduit cable sections requiring explosion-proofing.
 - ③ The compound must be filled at a sufficient depth and the attachment and hardening state must be acceptable.
 - ④ The state of the attachment of the electronic instrument must be acceptable.
 - (g) Inspection of connection area between wiring and electric instrument etc.
 - ① Proper access of terminal sign, polar circuits.
 - ② The connection area must be sufficiently tight and measurement must be made to prevent loosening.
 - ③ Connection section without terminal blocks etc must be clearly insulated.
 - (h) Inspection of container cover
 - ① There must be no damage or foreign matter on the cover access section or screw threads and it must be coated with non-hardening oils.
 - ② When packing is used for dust and water proofing, it must be installed properly.
 - ③ The screws must not be faulty and sufficiently tightened.
 - (i) The state if operation based on explosion-proof structure and conditions of use must be acceptable

< Basic Inspection Items >

Item	Method	Inspection Content	Notes
Container (explosion-proof box)	By eye	There must be no external damage (rust, dust)	cleaning, corrosion protection
Display window	By eye	There must be no damage by scraping etc	cleaning
Screws	By eye, touch	There must be no loosening, dust or rust	tighten, cleaning
Button	By eye, touch	There must be no loosening or breakage	tighten, replace
Power line inlet Cable gland	By eye, touch	There must be no damage, resolution or loosening	tighten, replace
Electric instrument (PC)	By eye	There must be no external damage and damage to power status	cleaning

1.3.2. Operation

(1) Operation Method

- (a) Check the cable connection and metallic wiring state of the installed product.
- (b) Apply power to the installed product.
- (c) Check if it is functioning normally.

(2) Operation Cautions and Prohibitions

- (a) Before using the product the learn user manual and use and install according to the given method.
- (b) This product must be constructed by qualified expert electrical construction personnel.

1.4 Maintenance and Cautions

1.4.1. Maintenance

- (1) This product requires continued management through periodic inspection (1 time or more per month recommended).
- (2) When maintaining electrical instruments the following items must be checked.
 - (a) There must be no damage to the container connection surface (screw).
 - (b) There must be no damage or cracks from shock to the container exterior.
 - (c) The screws must be uniform and sufficiently tight.
 - (d) Corrosion prevention treatment must have been sufficiently carried out to prevent rust on the container connection surface or exterior.

1.4.2. Preparations

- (1) Prepare tools, materials, replacement etc.
- (2) Determine and check the need for insulation and insulation range.
- (3) Check the presence of explosive gas and handle as a non explosion-proof area.
- (4) Operator knowledge and capacity.
- (5) Documents and diagrams related to the explosion prevention area (division diagram etc.).



1.4.3. Cautions

- (1) When inspecting during application of current, the body (cover) of the explosion-proof electrical instrument must not be opened.
 - (2) When maintaining in an explosion-proof area, ensure no shock sparks occur from tools etc.
 - (3) When maintaining and repairing, disassembly and assembly work related to the electrical instrument's explosion-proof capacity is accompanied. Therefore the explosion-proof capacity must be checked for all parts.
- ※ If the user cannot maintain or determine cause of failure, please contact the manufacturer.
(Contact numbers are included in the back of the manual)

2. Technical Specifications

2.1 Product Specifications

Product Name	Indicator		
Mode Name	EXI-200AD		
Explosion proof structure	Explosion proof	Ex d IIB +H ₂ T6 IP66	
	Dust ignition proof	Ex tD A21 85°C IP66	
Material container	Aluminum (AL)		
Power	AC Type	100 V ~ 240 V , 50/60 Hz	
		110 V	0.15 A
	DC Type	220 V	0.08 A
		12~24 V 1.5 A	
Product Size	218 (W) x 257 (H) x 152 (D)		
Temperature Range	-20 °C ~ +40 °C		
Product Weight	Approx. 15 kg		
Fuse Capacity	2 A 250 V		
Power Consumption	Approx. 3.9 W		

2.2 Product Labelling

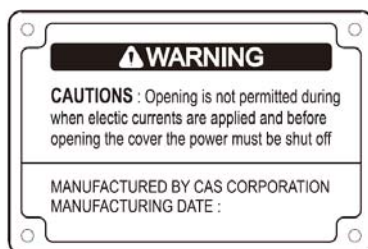
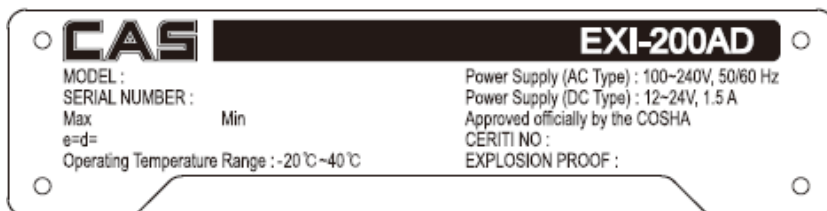

2.3 Product Structure and Composition

2.3.1. To form the body, an aluminum composite material suitable for the shaping and usage requirement of the product was selected.

2.3.2. The protective galss is tempered, explosion-proof structure formed by heat treatment and metallic molding to be capable of maintaining sufficient strength.

2.3.3. The wiring connections must be made of metal conduit tubing or a product of equal capacity.

(For all wiring material, only those that have been certified as explosion proof, or a greater safety level or passed the explosion proof efficiency inspection and are still within the certification expiry date are used)

2.3.4. When the product needs to be maintained or repaired after power is supplied to it,



“ Opening is not permitted during when electric currents are applied and before opening the cover the power must be shut off.”

2.4 Handling Cautions

2.4.1 Handling Cautions

(1) If the instrument is dropped or shock is applied to it there is a possibility of a reduction in capability. Therefore handle with care.

(2) If the instrument needs to be opened for installation, inspection, maintenance etc., the power must be cut and caution must be taken not to supply power when it is still open.

(3) When opening or closing the instrument be careful not to cause faults on the connecting surface. When locing the bolts make sure there is no foreign matter on the connecting surface and use tools to completely tighten.

(4) Do not open when applying electric currents

3. Features

3.1 Features

- High speed, High accuracy
- High speed micro processor adoption
- A/D conversion speed : Maximum 200 times/second
- Appropriate for weight and measurement system
- Easy operation and various options.
- Simple and prompt Full Digital Calibration (SPAC™: Single pass automatic span Calibration)
- RFI/EMI screened
- Watch Dog circuitry (System restoration)
- Weight Back-up
(Weight memory at sudden power failure)

3.2 Main Functions

- Store date, time and calculated data at sudden power failure.
- Various specification on weight conversion speed.
(Digital filter function)
- Various printer connection. (RS-232C Serial printer)
- Tare weight setting with keys.
- Storage of measured times.
- Set Point input & highest, lowest limit input.
- External input 2 relay.(option)
- External output 4 relay.(option)
- Users can set the desirous max. weight and a division freely.
- Control various external equipment by inner external input/output. (option)
- Print date and time by inner clock.
- Self hardware Test.

3.3 Product Specifications

Power supply		Unit
Power supply voltage	10~24(DC), 100V~240V(AC)	V
Max consumption	70 with 350 Ω	mA
Temperature range		
Storage temperature	-25~85	°C
Operating temperature	-20~40	°C
Loadcell		
Impedance(complete bridge)	> 80	Ω
Connection	4 or 6 wires	
Loadcell power supply	5 ± 5 %	Vdc
Communication		
RS485	Half duplex	
Baud rate	9600 ~ 115200	BPS
Logical inputs		
Numbers	2	
type	Optocoupler	
Low level voltage	0~3	Vdc
Higi level voltage	9~24	Vdc
Current at high level	10 mA@24 V	mA
Insulation voltage	2500	Vrms
Logical for use metrological characteristics		
Class	III or IIII	
Minimum voltage division per verification scale division	0.5	uV
Maximum voltage for weighing range	39	mV
Programmable functions		
Acquisition of zero, tare, zero tracking		
Physical or theoretical calibration		
Slope correction		
Non-linearity polynomial correction		

Low pass, band-stop and self-adaptive digital filters		
Set points managements		
Checkweigher functioning mode		
Peak detection functioning mode		
Option		
Display	7 Segment LED, 4 key	
A-Out	V-out, I-out	-10 V~10 V 0~24 mA
Relay I/O	2input, 4output	
Alibi memory	50,000ea Save Real time clock	
Ethernet	10/100 M	

4. External Explanation

4.1 External Specifications

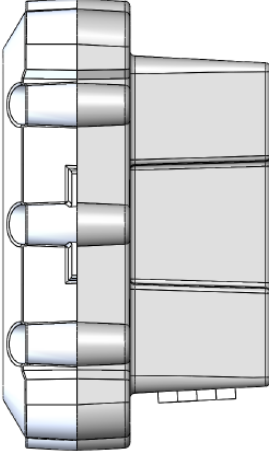
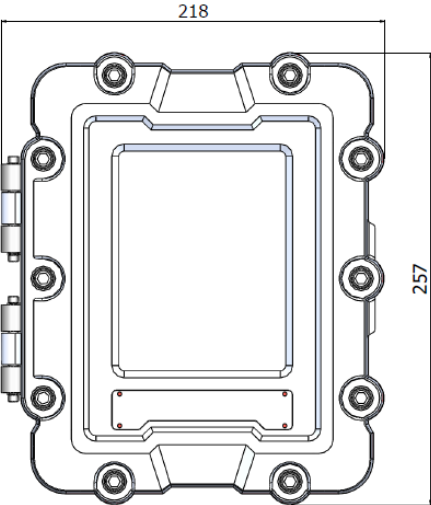
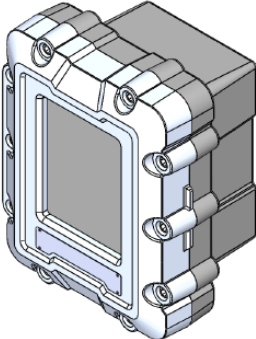
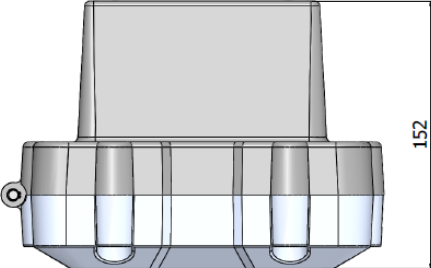

4.2 Frontal Surface Explanation

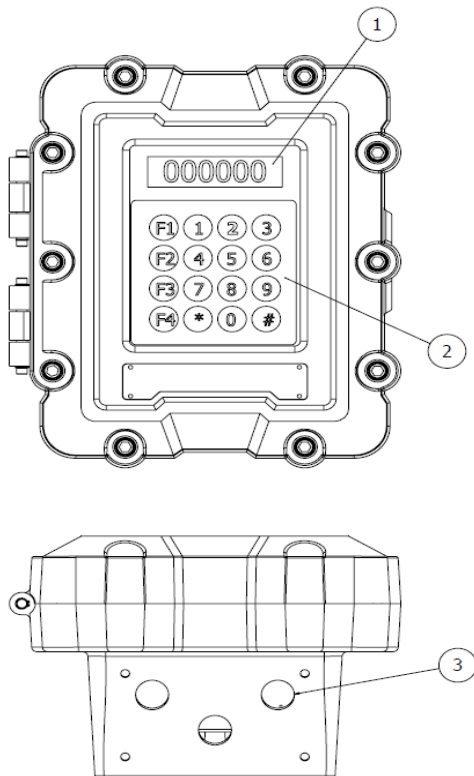

4.2.1 Detailed Explanation

No.	Name	Function		
①	Display	Displays the load weight, status, various messages etc.		
②	Key (touch key)	Used for function and data input.		
③	Wiring lead-in tool	Wiring inlet (3 openings total), 2 attachments standard, internal pressure packaging * Use a cable gland which satisfies the KCs explosion proof certification IP66..		
		Standard Inlet	Cable caliber	Joint screw diameter
		Left side : for load cell cable	6~13.5 mm	M20*1.5
Right side : for power cable				

4.2.2 Wiring entrance and ground connection explanation

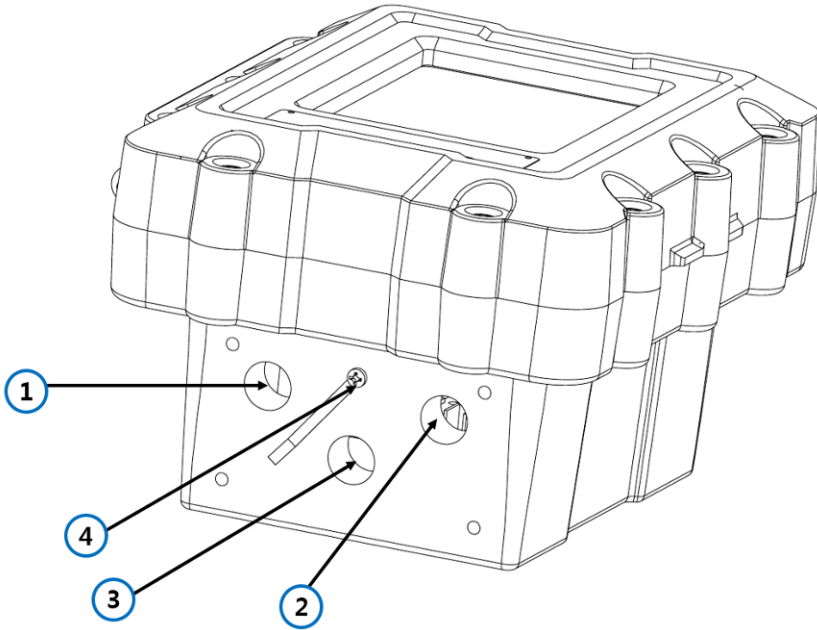

①	Load cell signal line wiring inlet
②	Power line wiring inlet
③	Wiring inlet for communication line or other optional lines
④	Ground wiring connector (select based on environment)

* Ensure wiring is installed in the designated positions as it may affect the capability of the product.

4.3 Display Explanantion



LED	Main function (F5-05 OFF Set)	Sub function (F5-05 ON Set)
○	Stable LED	LED ON : output 4 Closed
TARE	Tare LED	LED ON : output 3 Closed
NET	On = Net , Off = Gross	LED ON : output 2 Closed
→0←	Zero LED	LED ON : output 1 Closed
HOLD	Hold LED	LED ON : input 2 Closed
COMM	Data Communication LED	LED ON : input 1 Closed
	Key Operation LED	Not use







4.4 Key manual











4.4.1 EXI-200 KEY PAD



4.4.2 Function Key

- Functions of keys used in Normal Mode.

	<p>* Adjust the weight display near the zero-set to 0. (2%, 5%, 10%, 20%, 100% ranges can be selected.)</p>
	<p>* For every press, alternate between total/net load and display the weight with the lamp indicator.</p>
	<p>* Use the when weighing with the container. * Press the key to save the current weight as the container weight. * To remove the container press the key when the load board is empty.</p>
	<p>* Press the key to print the currently designated power format.</p>
	<p>* Use when checking the subtotal value (partial aggregate).</p>
	<p>* Use when checking the total value (aggregate).</p>

	* Use to change the product number.
	* Use to input the item code.
	* Use to change the Set Point.
	* Use when weighing a moving object.
	* Use when deleting all input.
	* Use to enter the menu mode.
	* Can be customized to suit the needs.
	* Can be customized to suit the needs.
	* Can be customized to suit the needs.
	* Can be customized to suit the needs.

4.4.3 Key Lock

-Set the Key Lock Function settings to "use", (F1-23. set 1) and if the Key Lock time setting is set to "10", (F1-24. set 10)

- The front touch key automatically locks if there is no key input for roughly 10 seconds.
(If the Key Lock function is activated, the Key status indicator on the display changes to ON)

- If the  is held down for approximately 2 seconds whilst the Key Lock function is set, the Key Lock function is cancelled.

5. Internal Explanation

5.1 Internal Explanation.

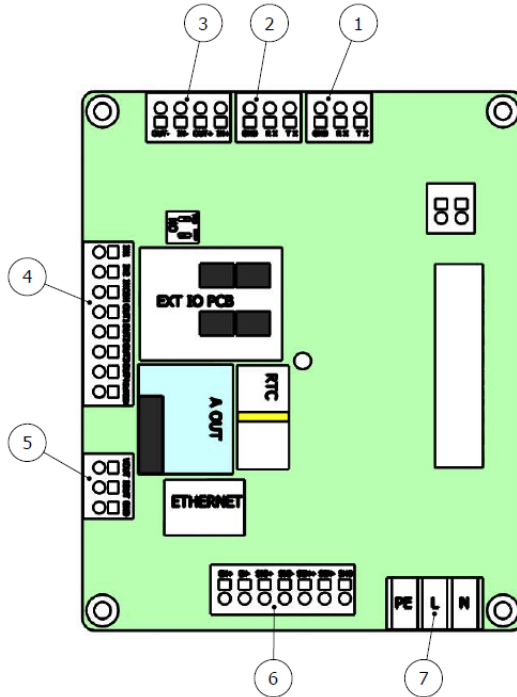

No.	Explanation	Notes
①	RS-232 connector(COM1)	Refer to 5.1.3
②	RS-232 connector (COM2)	Refer to 5.1.3
③	RS-485 connector	Refer to 5.1.3
④	RELAY connector	Refer to 5.1.4
⑤	A-OUT connector	
⑥	Load cell connector	Refer to 5.1.2
⑦	Power connector	Refer to 5.1.1

5.1.1 Power Connector (AC, DC)

- Before connecting always check the power requirements of the product.
- For fine measurement, measure for 10 minutes after power is turned on.

(1) AC Type

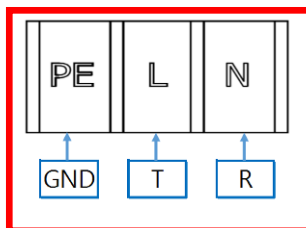
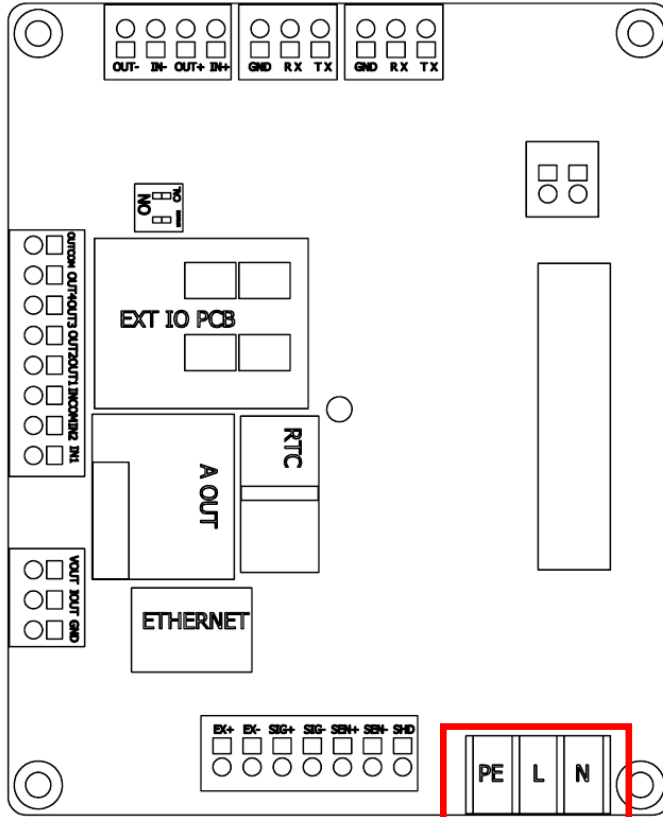

(2) DC Type

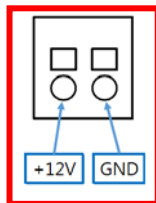
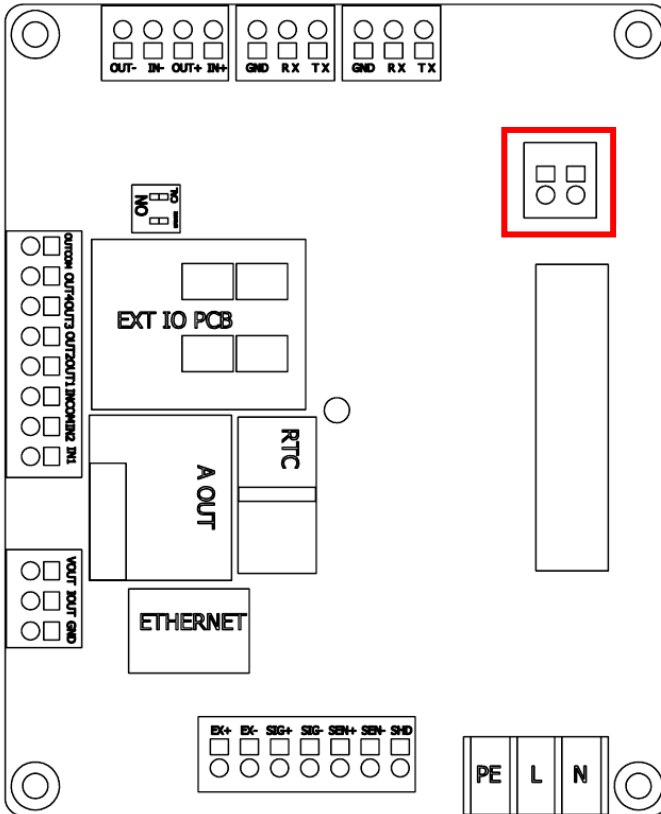

5.1.2 Load Cell Connector

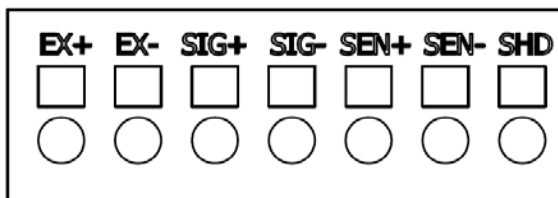
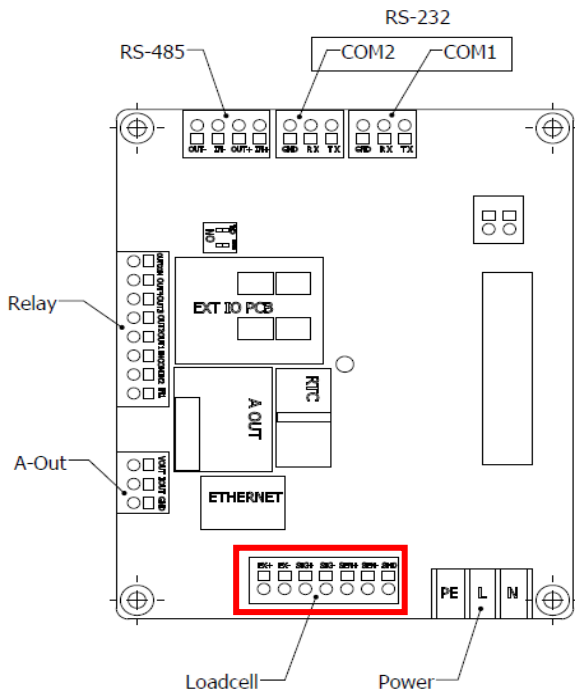

Note 1. In case of 4 wires load cell, connect EX+ with SEN+, and connect EX- with SEN-.

Note 2. Max 8 loadcells can connect to EXI-200(when loadcell impedance 350 Ω)

*** Relationship between the load cell output and input sensitivity.**

The input sensitivity of this product is maximum 0.3uV/digit or more.

The following equation should be satisfied upon the system design.

$$0.2\mu V \leq \frac{\text{Applied voltage of load cell} \times \text{Output voltage of load cell} \times \text{Value of a division}}{\text{Rated capacity of load cell} \times \text{Number of load cell}}$$

Example 1) Number of load cell: 4 ea

Rated capacity of load cell: 500 Kg

Rated output of load cell: 2mV/V

Value of a division: 0.10 Kg

Applied voltage of load cell: 5V (= 10,000 mV)

According to the equation → $(10000 \text{ mV} * 2\text{mV} * 0.1\text{Kg}) / (500\text{Kg} * 4) = 1 \geq 0.3\mu\text{V}$

As the calculated value is greater than 0.3uV, this weight system design has no problem.

5.1.3 RS-232, RS-485 Connector

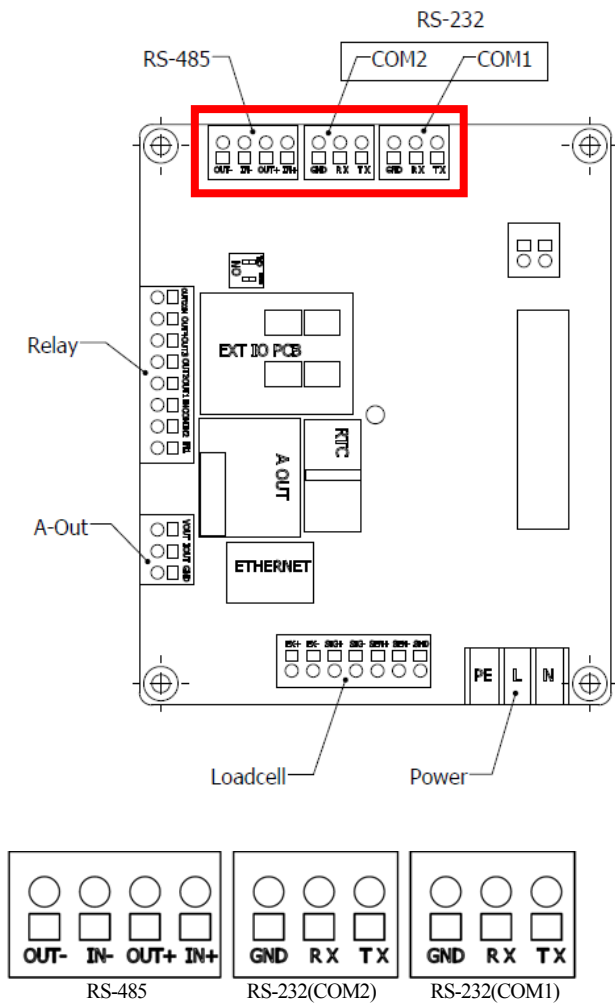

Pin Explanation	Connection	Note
Tx	PC D-SUB No.2	RS-232
Rx	PC D-SUB No.3	RS-232
GND	PC D-SUB No.5	RS-232
IN+	485 Converter T+	RS-485/422
IN-	485 Converter T-	RS-485/422
OUT+	485 Converter R+	RS-485/422
OUT-	485 Converter R-	RS-485/422

Reference 1. For the computer RS-422 and RS-485 line PIN numbers, please refer to the PCI card or converter (RS-422) manual.

Reference 2. The RS-422 method transfers signals by voltage difference and is more stable in terms of electric noise compared to other methods.

Shield Cable. In addition the wiring should be separated from the AC power cable or electric wiring and for cables communication-specific shield cables (0.5 ϕ or greater) should be used. The recommended use distance is within 1.2km.

5.1.4 Relay Input(Optional)

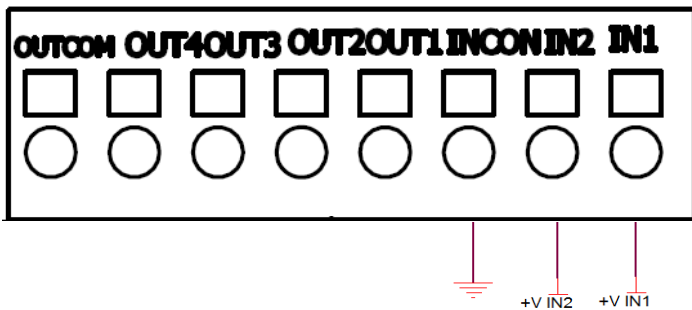
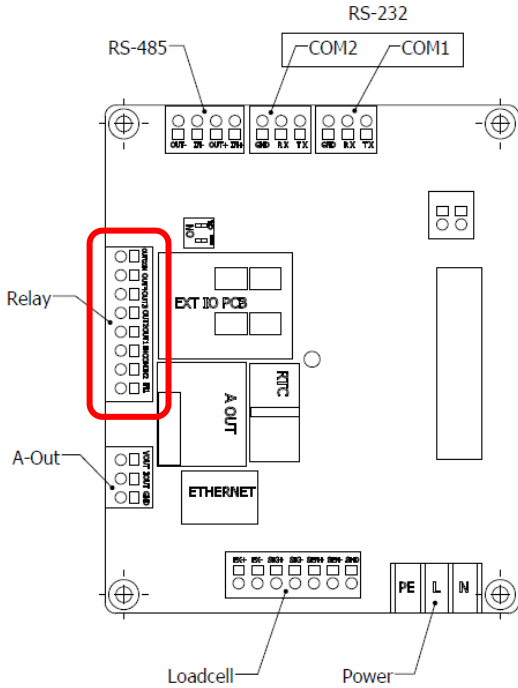

* If 5~24V voltage is applied to terminals IN1, IN2, signal is input into each Input unit.

6. Weight Calibration Mode

6.1 What is weight calibration?

Calibration for adjusting the weight display so the displayed value corresponds with the actual weight.

6.2 How to enter the weight calibration mode

To enter the weight calibration mode, open the front of the indicator and turn ON the power when the CAL S/W of the S/W depicted in the figure below is ON.



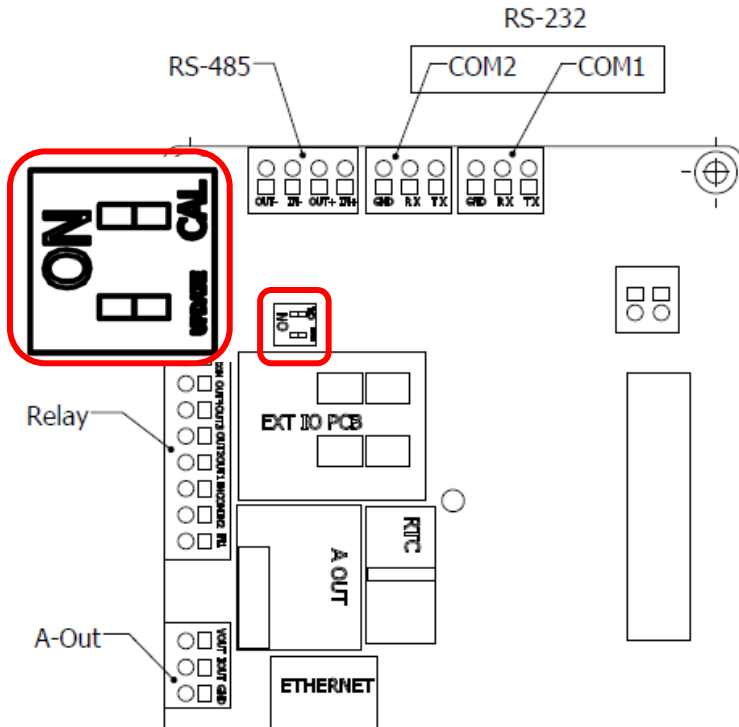

When weight calibration is complete, use after resetting the power.



6.3 Weight calibration menu (CAL1 – CAL9)





- CAL 1 : Maximum capacity calibration
- CAL 2 : Minimum division calibration
- CAL 3 : Zero-set and span calibration
- CAL 4 : Hopper weight setting
- CAL 5 : Direct calibration
- CAL 6 : Zero adjustment
- CAL 7 : Factor calibration
- CAL 8 : Gravity adjustment
- CAL 9 : Setting dual range

6.3.1 CAL 1 (Maximum capacity calibration)

Function: Setting Maximum Value Range of set value: 1 ~ 99,999		
Used key	Display	Descriptions
Using numeric keys Enter maximum weight  =Set,  =Cancel	  C= 10000	Max value = 10000 kg
	C= 10	Max value = 10 kg

Reference 1. The maximum capacity of the weighing scale can measure and display.

6.3.2 CAL 2 (Minimum division calibration)

Function: Minimum division and decimal position setting Range of set value: 0.001 ~ 50		
Used key	Display	Descriptions
Using numeric keys Enter minimum division  =Set,  =Cancel	  d= 0.001	Minimum division 0.001 kg
	d= 0.01	Minimum division 0.01 kg
	d= 0.1	Minimum division 0.1 kg
	d= 1	Minimum division 1 kg
Push  when entering a decimal print	d= 10	Minimum division 10 kg





Reference 1. When  CLEAR is pressed with decimal point calibrated, 'CAL2' is exited.

Reference 2. For external exploded view, set within the value of maximum capacity divided by the readability, '1/30,000'. If the external exploded view is greater than '1/30,000', 'Err20' will be displayed.

Reference 3. The decimal point positions is determined as the decimal position of the readability set from 'CAL2'.

6.3.3 CAL 3 (Zero-set and span calibration)



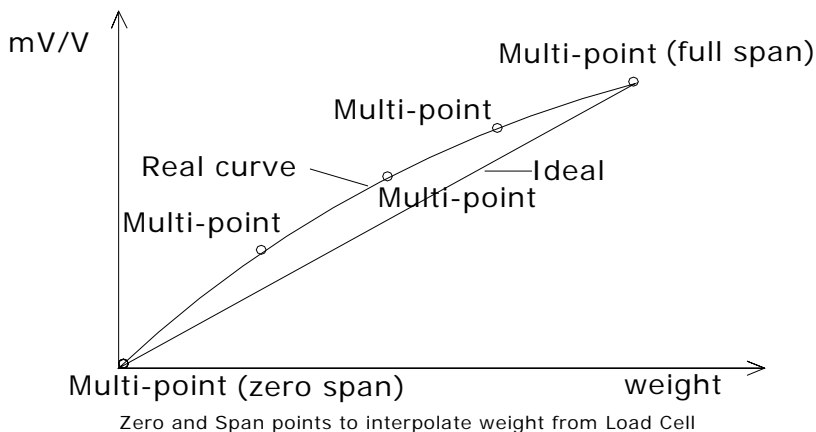

CAL 3-1

Function: Setting Multi Calibration Step Range of set value: 1~5		
Used key	Display	Descriptions
Using numeric keys Set the multi step,  =Set,  =Cancel	 	STEP- 1 Setting multi calibration for step 1 (CAL3-3 and CAL 3-4 are carried out once)
	STEP- 5	Setting multi calibration for step 5 (CAL3-3 and CAL 3-4 are carried out five times.)

* Function used to compensate the load cell power by calibrating multipoints in a particular sector when the actual curve of the load cell is not linear like it is in the figure below.







CAL 3-2

Function: Zero Calibration		
Used key	Display	Descriptions
   =Set,  =Cancel	UnLoAd 1234 - - -	Empty the load tray and press the setup key. The current weight value is displayed. Confirm 'Stable' and press the setup key. Zeroing in progress...



Reference 1. If the zeroing is completed without any error, it will automatically advance to the counterweight weight setting (CAL 3-3) with no need of further input.

CAL3-3

Function: Setting Weight Range of set value: 1 ~ 99,999		
Used key	Display	Descriptions
Using numeric keys Set the counterweight values  =Set,  =Cancel  	LOAD 1	It means the weight setting mode. (Number = multi calibration number)
	W=100.00	100.00 (unit: Kg or Ton)
	W= 0.10	0.10 (unit: Kg or Ton)

Reference 1. The counterweight should be set within 10~100% of the maximum capacity.

CAL3-4

Function: Weight Calibration		
Used key	Display	Descriptions
 =Set,  =Cancel	LoAd 12345 - - -	Load the weight set in CAL 4-3 and press the setup key. The current weight value is displayed. Confirm 'Stable' and press the setup key. Span adjustment in progress...

Reference 1. Repeat 'CAL3-3' and 'CAL3-4' according to the number of STEPS set in 'CAL 3-1'.



At this instance, the weight value must be set to be greater than the previous values.

Reference 2. If the span calibration is completed without any error, "SUCCESS" will be displayed and will advance to the weight verification mode.



Reference 3. If there are no problems after weight verification, pressing  key will move to 'CAL3'.

6.3.4 CAL 4 (Hopper weight setting)

CAL 4-1



Function: Setting Multi Calibration Step Range of set value: 2 ~ 5		
Used key	Display	Descriptions
Using numeric keys Set the range.  =Set,  =Cancel	STEP- 2	Setting multi calibration for step 2 (for hopper system)
	STEP- 5	Setting multi calibration for step 5 (for hopper system)

CAL 4-2

Function: Setting Weight Range of set value: 1 ~ 99,999		
Used key	Display	Descriptions
Using numeric keys Set the counterweight values  =Set,  =Cancel	LOAD 1	It means the weight setting mode. (Number = multi calibration number)
	W=100.00	100.00 (unit: Kg or Ton)
	W= 0.10	0.10 (unit: Kg or Ton)

Reference 1. Set the counterweight within 10~100% of the maximum capacity.

CAL 4-3

Function: Weight Calibration		
Used key	Display	Descriptions
 =Set,  =Cancel	LoAd 12345 - - -	Load the weight set in CAL 4-3 and press the setup key. The current weight value is displayed. Confirm 'Stable' and press the setup key. Span adjustment in progress...





Reference 1. Repeat 'CAL4-2', 'CAL4-3' according to the number of STEPs set in 'CAL 4-1'.

At this instance the weight value should be calibrated to be greater than the previous values.





Reference 2. If the span calibration is completed without error, it will advance to CAL-4.

6.3.5 CAL 5 (Direct Calibration))





CAL 5-1

Function: Direct input about the zero value of loadcell Range of set value: 1 ~ 99,999		
Used key	Display	Descriptions
Using numeric keys Enter the output value.  =Set,  =Cancel  	ZE-CAL	Direct zero input mode
	0.0000	Loadcell zero = 0.0000 mV/V
	0.1000	Loadcell zero = 0.1000 mV/V

CAL 5-2

Function: Direct input about the span value of loadcell Range of set value: 1 ~ 99,999		
Used key	Display	Descriptions
Using numeric keys Enter the output value.  =Set,  =Cancel  	SP-CAL	Direct span input mode
	1.2000	Loadcell span = 1.2000 mV/V
	2.0000	Loadcell span = 2.0000 mV/V









6.3.6 CAL 6 (Zero-set adjustment)

Function: Zero adjustment - calibration when any zeroing error occurs.		
Used key	Display	Descriptions
   =Set,  =Cancel	2-CAL 1234 - - -	Empty the load tray and press the setup key. The current weight value is displayed. Confirm 'Stable' and press the setup key. Zero adjustment in progress...

Reference 1. Use when the zeroing is failing due to shock. (Zero-set range is 0~2 mV/V)

Reference 2. If zero-set adjustment is completed without error, advance to 'CAL-1'.

6.3.7 CAL 7 (Factor Calibration)





Function: Factor Calibration		
Used key	Display	Descriptions
Using numeric keys Set the weight factor.    =Set,  =Cancel  Push  when entering a decimal print	  0 9 NOTUSE FACTor 12345	This function cannot be used because of multi calibration. It means you entered the factor correction mode. The current factor is displayed.

Reference 1. This menu is for weight calibration when counterweight is not available. Regular users will not need to use this.

Reference 2. Can only be used when the multicalibration range of 'CAL3-1' is set to 1.

Reference 3. To enter the FACTOR adjustment mode, PASSWORD must be entered.



6.3.8 CAL 8 (Gravity correction)

Function: Gravity Adjustment		
Used key	Display	Descriptions
<p>Using numeric keys Enter an initial gravity value.</p>  <p>=Set, =Cancel</p> <p>Push  when entering a decimal print</p>	<p>G-CAL</p> <p>Gr-CAL 9.XXXX</p> <p>Gr-SET 9.XXXX</p>	<p>It means you accessed to the menu for the gravity adjustment.</p> <p>Set the gravity for the production place.</p> <p>Set the gravity for the place to use the product.</p>

Reference 1. If the gravity between the indicator production location and the location of use is different, gravity can be corrected using this function.

6.3.9 CAL 9 (Dual range setting)

CAL 9-1

Function: Setting Dual Range Range of set value: 0 ~ 1		
Used key	Display	Descriptions
<p>Set the use status for dual function</p>  <p>=Set, =Cancel</p>	DUAL- 0	Dual range function is not used.
	DUAL- 1	Dual range function is used.

Reference 1. If the resolving power is greater than 1/10,000, "OVER" will be displayed and will return to the CAL menu mode.

CAL9-2

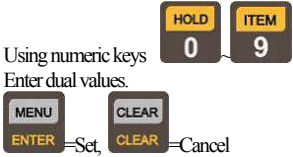

Function: Setting the applied section for the Dual Range Range of set value: 0 ~ 99999		
Used key	Display	Descriptions
<p>Using numeric keys Enter dual values.</p> 	M 1000	Dual range is applied to less than 1000kg.
	M 5000	Dual range is applied to less than 5,000kg.
	M 10000	Dual range is applied to less than 10,000kg.

Reference 1. If the input value is greater than the maximum capacity, "ERR SET" will be displayed and will return to the CAL menu mode.

7. Weighing Mode

7.1 Zero-set Function (used when changing the zero-set)

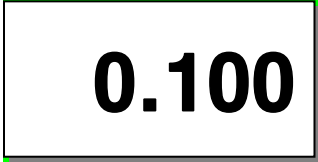

- Zero-set range: within the range set in F1.09

	Display Part or Used Keys	Load Plate	Description
Step 1		Empty	State with zero changed
Step 2			Push the zero key
Step 3		Empty	State after performing zero function. Namely, the current weight is designated as 0kg.



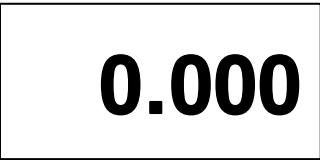

7.2 Tare function (used when weighing using a container)

■ **Maximum tare setting range: maximum capacity**





* Caution: The weight value including the container weight cannot exceed the maximum capacity.

	Display Part or Used Keys	Load Plate	Description
Step 1		Tare Placement	State with tare placed on load plate Weight plate : 1.000 kg
Step 2			Push the tare key
Step 3		Tare	State with NET lamp turned ON and tare registered

7.3 Item number changing

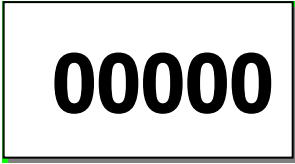

	Display Part or Used Keys	Load Plate	Description
Step 1			Press Item number key.
Step 2			Item Code = 1
Step 2			Change the item number.
Step 3			Item number is saved

7.4 Set point changing

	Display Part or Used Keys	Load Plate	Description
Step 1			Press the Item key
Step 2			Displayed current setpoint number.
Step 2	 		Change the set point value
Step 3			Set point is saved
Step 4			Repeat step1~3 until end point of max set point

7.5 Subtotal Print

The product number of the steel reinforcement is assumed to be '10'.



	Display Part or Used Keys	Load Plate	Description
Step 1			Select the item number code as '10'
Step 2			Push No.5(Subtotal) key "No.5 key pushed" is displayed in the message window
Step 3			The subtotal value of item No.10 is printed in the designated form.

Reference 1. The print format is designated as below.

----- SUB-TOTAL -----	
DATE	2012/ 1/ 1
TIME	09:30
ID	1
COUNT	5
TOTAL	350.0 kg

Reference 2. The subtotal DATA is automatically or manually deleted based on the menu number[F7-03].

7.6 Total Print

	Display Part or Used Keys	Load Plate	Description
Step 1			Push No.5(Total)key "No.5 key pushed" is displayed in the message window
Step 2			Sum of all subtotal information item Nos.0-99 is printed as in the designated form.



Reference 1. The print format is designated as below.

----- GRAND-TOTAL -----	
DATE	2012/ 1/ 2
TIME	10:30
ID	10
COUNT	123
TOTAL	12350.0 kg

Reference 2. The subtotal DATA is automatically or manually deleted based on the menu number[F7-03].

8. Test Mode

How to enter test mode



Press the  key whilst in normal mode and select test mode by pressing  key.

After testing in test mode, press  key to enter weighing mode.

















Test Menu (1 – 9)

- 1 : Key Test
- 2 : Display Test
- 3 : AD Test
- 4 : Communication Test
- 5 : External Input/output Test(OPTION)
- 6 : A-OUT Test(OPTION)
- 7 : 1/10 division Test
- 8 : EEPROM Test
- 9 : RTC Test (OPTION)







8.1 TEST 1 (Key Test)

Function: Key test		
Used key	Display	Descriptions
  : Next Menu Other keys : Test	KEY 01	When you press any key to test, the number and code for the key are displayed on the screen.

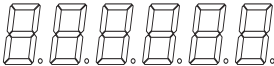

< Key List >

Key	No	Code	Key	No	Code	Key	No	Code
 1	1	1	 7	7	7	 F3	F3	30
 2	2	2	 8	8	8	 F4	F4	31
 3	3	3	 9	9	9	 CLEAR	CLEAR	27
 4	4	4	 0	0	0	 MENU	ENTER	30
 5	5	5	 F1	F1	28			
 6	6	6	 F2	F2	29			

8.2 TEST 2 (Display Test)

Function: Display Screen Test		
Used key	Display	Descriptions
  : Cancel   : Next Menu	 	All LED lamp is on.

8.3 TEST 3 (AD Test)

Function: Load cell test and A/D conversion test		
Used key	Display	Descriptions
 : Cancel  : Next Menu	XXXXXX	The internal value for the current weight value is displayed.



Reference 1. Press  to display the load cell output as m/V units.

8.4 TEST 4 (Communication Test)

Function: Serial Communication Test		
Used key	Display	Descriptions
 : Next Menu Other keys: Test	Tx -- Rx ----- 02 -04	Status to wait for transmission or reception Transmission: 2, Reception: 13

Reference 1. Run this test while the communication program in the computer (ex: Hyper Terminal) is executing after connecting a serial port in the computer to the serial port on the back.



Reference 2. Send '1' from the computer keyboard, check whether or not '1' is received properly on the indicator's screen, and then check whether or not '1' is received properly on the computer after pressing '1' from the indicator's keyboard.

8.5 TEST 5 (External Input/output Test OPTION)

Function : External Input / Output Test		
Used key	Display	Descriptions
 : Next Menu Other keys: Test	I - X O - X ----- I - 2 O - 4	Displayed in the external input section when there is an external input. Push ▲ key to execute weighing external output input : 2, output : 4



Reference 1. This test operates only if Ext IO Option Card is mounted

8.6 TEST 6 (A-OUT Test OPTION)



Function : A-Out Test		
Used key	Display	Descriptions
  : Next Menu Other keys : Test	25 P	The output level of Aout is raised by 25% each time the ▲ key is pushed.

Reference 1. This test operates only if Analog out Option Card is mounted.



8.7 TEST 7 (1/10 division Test)

Function: 1/10 division Test		
Used key	Display	Descriptions
  : Next Menu	XXXXXX	Display as 1/10 weighing scale units.

8.8 TEST 8 (EEPROM Test)

Function: EEPROM Test		
Used key	Display	Descriptions
  : Next Menu	ROM OK ROM NG	Display EEPROM status

8.9 TEST 9 (RTC Test OPTION)



Function: RTC Test		
Used key	Display	Descriptions
  : Next Menu	SEC XX	XX : Displaying the progress of seconds (SEC)

Reference 1. This test only functions if the (subtotal)RTC option card is installed.

Reference 2. Press  key to reset seconds (SEC).

9. Set Mode

9.1 How to enter set mode

Press  whilst in normal mode and select Set Mode by pressing  key.

After testing in set mode, press  to enter weighing mode.

Classification	Menu	SubMenu
1. General Setting	F1.01	Set AD speed
	F1.02	Set average filter
	F1.03	Set Low Pass Filter
	F1.04	Set Band Stop Filter
	F1.05	Not use
	F1.06	Set stable range
	F1.07	Set Automatic Zero Tracking Compensation
	F1.08	Set Weight Back-up
	F1.09	Set Zero range
	F1.10	Set Tare range
	F1.11	Set Init Zero
	F1.12	Set Weighing Unit
	F1.13	Set F1 Key Use Type
	F1.14	Set F2 Key Use Type
	F1.15	Set F3 Key Use Type
	F1.16	Set F4 Key Use Type
	F1.17	Set Hold Type
	F1.18	Set Average Hold time
	F1.19	Set Hold Canceling Conditions
	F1.20	Set Automatic Hold Starting Conditions
	F1.21	Set Automatic Hold Canceling Conditions
	F1.22	Set Key Operating Conditions
	F1.23	Set use Key Lock
	F1.24	Set Key Lock time
	F1.25	Initializing of set values
	F1.26	Set Key Sensitivity

Classification	Menu	SubMenu
2. Communication Setting	F2.01	Set Device ID
	F2.02	Set Data Transmission Rate
	F2.03	Set COM1 Port Setting
	F2.04	Set COM1 Baud Rate
	F2.05	Set COM1 Out Data
	F2.06	Set COM1 Output Format
	F2.07	Set COM1 Output mode
	F2.08	Set COM2 Port Setting
	F2.09	Set COM2 Baud Rate
	F2.10	Set COM2 Out Data
	F2.11	Set COM2 Output Format
	F2.12	Set COM2 Output mode
	F2.13	Set RS-422/485 Port Setting
	F2.14	Set RS-422/485 Baud Rate
	F2.15	Set RS-422/485 Out Data
F2.16	Set RS-422/485 Output Format	
F2.17	Set RS-422/485 Output mode	

Classification	Menu	SubMenu
3. A-Out Setting	F3.01	A-out Range
	F3.02	V-out Range
	F3.03	I-out Range
	F3.04	Dual output mode
	F3.05	Minimum weight of A-out
	F3.06	Maximum weight of A-out
	F3.07	Adjust zero of A-out
	F3.08	Adjust span of A-out

Classification	Menu	SubMenu
4. Device Setting	F4.01	Set Date
	F4.02	Set Time
	F4.03	Use Alibi memory
	F4.04	Memory over writing

Classification	Menu	SubMenu
5. Relay Setting	F5.01	Relay Out mode
	F5.02	Ext input 1
	F5.03	Ext input 2
	F5.04	Relay Reverse On/Off
	F5.05	Relay Display

Classification	Menu	SubMenu
6. TCP.IP	F6.01	Set DHCP
	F6.02	Set Server /Client
	F6.03	EXI-200's IP Server mode
	F6.04	Subnet Mask
	F6.05	Gate way
	F6.06	EXI200's TCP Port Server mode
	F6.07	Comm type of Server mode
	F6.08	Set Client IP
	F6.09	Set Client's TCP Port
	F6.10	Comm type of Client mode

Classification	Menu	SubMenu
7. Print Function	F7.01	Print Type
	F7.02	Print Form
	F7.03	Manage Print Data
	F7.04	Print Line Feed
	F7.05	Print Head Message
	F7.06	Print Delay Time
	F7.07	Print Condition
	F7.08	Print Set Automatic
	F7.09	Print Count Number

9.2 General Function

Menu-F1.01: Set AD Speed

Function	AD Speed Setting	
Set Range (0~8)	Display Part	Meaning
	1-01. 0	Converting speed 5 times per second
	1-01. 1	Converting speed 10 times per second
	1-01. 2	Converting speed 20 times per second
	1-01. 3	Converting speed 40 times per second
	1-01. 4	Converting speed 100 times per second
	1-01. 5	Converting speed 160 times per second
	1-01. 6	Converting speed 320 times per second
	1-01. 7	Converting speed 800 times per second
1-01. 8	Converting speed 1600 times per second	

Reference 1. After changing the AD speed, press  to display the weight using the altered value.

(Press  after checking the changed value to return to the previous mode)

Menu-F1.02: Set average filter

Function	Average filter Setting	
Set Range (1~50)	Display Part	Meaning
	1-02 : XX Initial Value : 10	Setting the number of buffers in the average filter

Reference 1. Set based on the environment. (The rate of change of weight may slow)

Menu-F1.03: Set Low Pass Filter

Function	Low Pass Filter Setting	
Set Range (0~1)	Display Part	Meaning
	1-03 : XX Initial Value : 0	Low Pass Filter use setting. (0: Not use, 1: Use)
Set Range (2~4)	F-od.XX Initial Value : 2	Low Pass Filter Degree setting.
Set Range (1~1600)	C-FrEq Initial Value : 10	Low Pass Filter Frequency setting

Reference 1. Uses the LPF (Low Pass Filter). The LPF order and LPF frequency setting menus are only displayed in this mode.

Reference 2. When using LPF, set according to the environment.

Menu-F1.04: Set Band Stop Filter

Function	Band Stop Filter Setting	
	Display Part	Meaning
Set Range (0~1)	1-04: XX Initial Value : 0	Band Stop Filter use setting. (0: Not use, 1: Use)
Set Range (1~1600)	H-FrEq Initial Value : 60	Band Stop Filter High Frequency setting.
Set Range (1~1600)	L-FrEq Initial Value : 10	Band Stop Filter Low Frequency setting.

Reference 1. Uses BSP (Band Stop Filter). The BSP High Frequency, BSP Low Frequency setting menus are only displayed in this mode.

Reference 2. When using BSP, set according to the environment.

Menu-F1.06: Set Stable Weight Range

Function	Stable Weight Range Setting	
	Display Part	Meaning
Set Range (0~99)	1-06. XX Initial Value : 1x 0.5 division	Stability lamp is turned ON when weight change is such that the width of change in a given time is within the set value x 0.5 division

Reference 1. This function verifies the stable status when the weight fluctuation does not exceed 0.5x the readability setting within the set time.

Reference 2. The number should be made large and small for high-vibration and low-vibration environments respectively to quickly stabilize the weighing status.

Menu-F1.07: Set Automatic Zero-set Range

Function	Automatic Zero-set Range Setting	
	Display Part	Meaning
Set Range (0~99)	1-07. XX Initial Value : 1x 0.5 division	Stability lamp is turned ON when weight change is such that the width of change in a given time is within the set value x 0.5 division

Reference 1. This function automatically corrects the zero-set if the weight does not exceed a set readability range within a set time when at zero-set state.

Ex) If the MENU [F1-07] is set to "2" when the maximum labeled increment is 120.0kg and the value of a single increment is 0.05kg

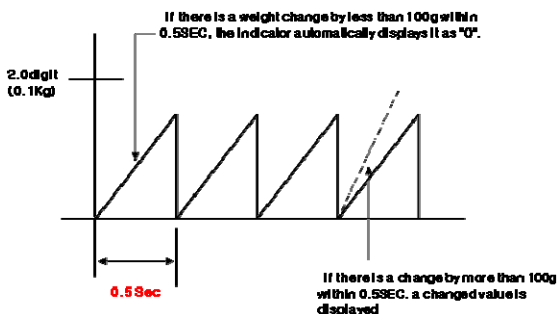

Menu-F1.08: Set Weight Back-up

Function	Weight Back-up Setting	
Set Range (0, 1)	Display Part	Meaning
	1-08. 0	Weight back up function is not used
	1-08. 1	Weight back up is used (based on operation)

Menu-F1.09: Set Zero Key Range

Function	Zero Key Range Setting	
Set Range (0-99)	Display Part	Meaning
	1-09. XX	Zero operates up to within +/- 00% of the maximum weight
	Initial Value : 10 %	

Menu-F1.10: Set Tare Key Range

Function	Tare Key Range Setting	
Set Range (0-100)	Display Part	Meaning
	1-10. XX	Tare operates up to within +/- 00% of the maximum weight
	Initial Value : 100 %	

Menu-F1.11: Set Initial Zero Range

Function	Initial Zero Range Setting	
Set Range (0-99)	Display Part	Meaning
	1-11. XX	Initial zero operates within +/- 00% of the Gross Weight
	Initial Value : 10 %	

Menu-F1.12: Set Overload Range

Function	Overload Range Setting	
Set Range (0-99)	Display Part	Meaning
	1-12. XX	Overweight from the next to 0 x 1 Digit of the maximum weight
	Initial Value : 9 x 1 Digit	

Menu-F1.13: Set F1 Key Use Type

Function	F1 Key Use Type Setting	
Set Range (0-8)	Display Part	Meaning
	1-13.00	F1 Key used as the tare/tare cancelling key
	1-13.01	F1 Key used as the total/net weight key
	1-13.02	F1 Key used as the Hold key
	1-13.03	F1 Key used as the Holdless key
	1-13.04	F1 Key used as the Tare key
	1-13.05	F1 Key used as the Cleaning key
	1-13.06	F1 Key used as the Tare cancelling key
	1-13.07	F1 Key used as the Set Point 1 key
1-13.08	F1 Key used as the Set Point 2 key	

Menu-F1.14: Set F2 Key Use Type

Function	F2 Key Use Type Setting	
Set Range (0-8)	Display Part	Meaning
	1-14.00	F2 Key used as the tare/tare cancelling key
	1-14.01	F2 Key used as the total/net weight key
	1-14.02	F2 Key used as the Hold key
	1-14.03	F2 Key used as the Holdless key
	1-14.04	F2 Key used as the Tare key
	1-14.05	F2 Key used as the Cleaning key
	1-14.06	F2 Key used as the Tare cancelling key
	1-14.07	F2 Key used as the Set Point 1 key
1-14.08	F2 Key used as the Set Point 2 key	

Menu-F1.15: Set F3 Key Use Type

Function	F3 Key Use Type Setting	
Set Range (0-8)	Display Part	Meaning
	1-15.00	F3 Key used as the tare/tare cancelling key
	1-15.01	F3 Key used as the total/net weight key
	1-15.02	F3 Key used as the Hold key
	1-15.03	F3 Key used as the Holdless key
	1-15.04	F3 Key used as the Tare key
	1-15.05	F3 Key used as the Cleaning key
	1-15.06	F3 Key used as the Tare cancelling key
	1-15.07	F3 Key used as the Set Point 1 key
1-15.08	F3 Key used as the Set Point 2 key	

Menu-F1.16: Set F4 Key Use Type

Function	F4 Key Use Type Setting	
Set Range (0~8)	Display Part	Meaning
	1-16.00	F4 Key used as the tare/tare cancelling key
	1-16.01	F4 Key used as the total/net weight key
	1-16.02	F4 Key used as the Hold key
	1-16.03	F4 Key used as the Holdless key
	1-16.04	F4 Key used as the Tare key
	1-16.05	F4 Key used as the Cleaning key
	1-16.06	F4 Key used as the Tare cancelling key
	1-16.07	F4 Key used as the Set Point 1 key
1-16.08	F4 Key used as the Set Point 2 key	

Menu-F1.17: Set Hold Type

Function	Hold Type Setting	
Set Range (0~3)	Display Part	Meaning
	1-17.00	Average Value Hold
	1-17.01	Peak Hold
	1-17.02	Sampling Hold
	1-17.03	Automatic Hold

Menu-F1.18: Set Average hold time

Function	Average hold time Setting	
Set Range (00~99)	Display Part	Meaning
	1-18.XX	Average value within the set value x sec is calculated
	Initial Value : 30	

Menu-F1.19: Set Hold Canceling Conditions

Function	Hold Canceling Conditions Setting	
Set Range (0~2)	Display Part	Meaning
	1-19.00	Hold is canceled when it becomes zero
	1-19.01	Hold is canceled when Hold key is entered
	1-19.02	Hold is canceled when Hold less key entered

Menu-F1.20: Set Automatic Hold Starting Conditions

Function	Automatic Hold Starting Conditions Setting	
Set Range (2~99)	Display Part	Meaning
	1-20.XX	Hold Starts when the weight changes within the set range value x 1 division
	Initial Value : 10	

Menu-F1.21: Set Automatic Hold Canceling Conditions

Function	Automatic Hold Canceling Conditions Setting	
Set Range (00~99)	Display Part	Meaning
	1-21. XX Initial Value : 10	Hold is canceled when the value is changed by more Than 00 % of the hold value

Menu-F1.22: Set Key Operating Conditions

Function	Key Operating Conditions(Zero, Tare) Setting	
Set Range (0, 1)	Display Part	Meaning
	1-22. 0	Always in operation
	1-22. 1	Operates only if the weight is stable

Menu-F1.23: Set use Key Lock

Function	Key Lock use Setting	
Set Range (0, 1)	Display Part	Meaning
	1-23. 0	Unlock front key
	1-23. 1	Lock front key

Menu-F1.24: Set Key Lock time

Function	Key Lock Time Setting	
Set Range (0~99)	Display Part	Meaning
	1-24. XX Initial Value : 10	Lock front key when setting value x 1 seconds exceeded

Reference 1. Can be used when the F1.23 Use Key Lock Setting is set to 1.

Menu-F1.25: Initializing of set values

Function	Initializing of set values	
Set Range (0, 1)	Display Part	Meaning
	1-25. 0	No set values of the product are initialized to factory shipping state
	1-25. 1	All set values of the product are initialized to factory shipping state

Menu-F1.26: Set Key Sensitivity

Function	Set Key Sensitivity	
Set Range (0~3)	Display Part	Meaning
	1-26. 0	Key sensitivity is very low.
	1-26. 1	Key sensitivity is low.
	1-26. 2	Key sensitivity is high.
	1-26. 3	Key sensitivity is very high.

Reference 1. If the key sensitivity is set high, it may be sensitive to external noise.

9.3 Communication Setting

Menu-F2.01: Equipment Number

Function	Equipment Number	
Set Range (0~99)	Display Part	Meaning
	2-01. XX	Desired device ID may be entered.
	Initial Value : 0	

Reference 1. This function can be used as the indicator unique ID when using COMMAND mode.

Menu-F2.02: Data Transfer Speed Setting

Function	Data Transfer Speed Setting	
Set Range (0~9999)	Display Part	Meaning
	XXXX	Data are transmitted by the unit of 00 x 10ms
	Initial Value : 50x10ms	

Reference 1. When set to "0", data is transferred in real-time.

Menu-F2.03: Set COM1 Port

Function	Com1 RS-232C Port Setting	
Set Range (0~5)	Display Part	Meaning
	2-03. 0	Data Bit 8, Stop Bit 1, Parity Bit : None
	2-03. 1	Data Bit 7, Stop Bit 1, Parity Bit: Even
	2-03. 2	Data Bit 7, Stop Bit 1, Parity Bit: Odd
	2-03. 3	Data Bit 7, Stop Bit 2, Parity Bit: Odd
	2-03. 4	Data Bit 8, Stop Bit 1, Parity Bit: Even
2-03. 5	Data Bit 8, Stop Bit 1, Parity Bit: Odd	

Menu-F2.04: Set COM1 Baud Rate

Function	COM1 RS-232C Baud Rate Setting	
Set Range (0~7)	Display Part	Meaning
	2-04. 0	1,200 bps
	2-04. 1	2,400 bps
	2-04. 2	4,800 bps
	2-04. 3	9,600 bps
	2-04. 4	19,200 bps
	2-04. 5	38,400 bps
	2-04. 6	57,600 bps
2-04. 7	115,200 bps	

Menu-F2.05: Set COM1 Out Data

Function	COM1 RS-232C Out Data Setting	
Set Range (0~2)	Display Part	Meaning
	2-05. 0	Displayed value is transmitted
	2-05. 1	Gross Weight is transmitted
2-05. 2	Net weight is transmitted	

Menu-F2.06: COM1 Output Format

Function	COM1 RS-232C Output Format	
Set Range (0~3)	Display Part	Meaning
	2-06. 0	22 byte of CAS
	2-06. 1	10 byte of CAS
	2-06. 2	18 byte Format(AND, FINE)
	2-06. 3	22 byte of CAS with relay status

Reference 1. Refer to <Appendix 1> for the communication format

Menu-F2.07: COM1 Communication Method

Function	COM1 Communication Method (RS-232C - Output mode)	
Set Range (0~8)	Display Part	Meaning
	2-07. 0	Data is not transmitted
	2-07. 1	Transmitted only if the print key is pushed
	2-07. 2	Transmitted in both stable/unstable cases (Stream Mode)
	2-07. 3	Transmitted only if the weight is stable
	2-07. 4	Command Type 1
	2-07. 5	Command Type 2
	2-07. 6	Command Type 3
	2-07. 7	Transmitted only upon completion signal
2-07. 8	Modbus protocol	

Reference 1. Refer to Appendix 2, 3 and 4 for command types.

Menu-F2.08: Set COM2 Port

Function	COM2 RS-232C Port Setting	
Set Range (0~5)	Display Part	Meaning
	2-03. 0	Data Bit 8, Stop Bit 1, Parity Bit : None
	2-03. 1	Data Bit 7, Stop Bit 1, Parity Bit: Even
	2-03. 2	Data Bit 7, Stop Bit 1, Parity Bit: Odd
	2-03. 3	Data Bit 7, Stop Bit 2, Parity Bit: Odd
	2-03. 4	Data Bit 8, Stop Bit 1, Parity Bit: Even
2-03. 5	Data Bit 8, Stop Bit 1, Parity Bit: Odd	

Menu-F2.09: Set COM2 Baud Rate

Function	COM2 RS-232C Baud Rate Setting	
Set Range (0~7)	Display Part	Meaning
	2-09. 0	1,200 bps
	2-09. 1	2,400 bps
	2-09. 2	4,800 bps
	2-09. 3	9,600 bps
	2-09. 4	19,200 bps
	2-09. 5	38,400 bps
	2-09. 6	57,600 bps
2-09. 7	115,200 bps	

Menu-F2.10: Set COM2 Out Data

Function	COM2 RS-232C Out Data Setting	
Set Range (0~2)	Display Part	Meaning
	2-10. 0	Displayed value is transmitted
	2-10. 1	Gross Weight is transmitted
	2-10. 2	Net weight is transmitted

Menu-F2.11: COM2 Output Format

Function	COM2 RS-232C Output Format	
Set Range (0~3)	Display Part	Meaning
	2-11. 0	22 byte of CAS
	2-11. 1	10 byte of CAS
	2-11. 2	18 byte Format(AND, FINE)
	2-11. 3	22 byte of CAS with relay status

Reference 1. Refer to <Appendix 1> for the communication format

Menu-F2.12: COM2 Communication Method

Function	COM2 Communication Method (RS-232C - Output mode)	
Set Range (0~8)	Display Part	Meaning
	2-12. 0	Data is not transmitted
	2-12. 1	Transmitted only if the print key is pushed
	2-12. 2	Transmitted in both stable/unstable cases (Stream Mode)
	2-12. 3	Transmitted only if the weight is stable
	2-12. 4	Command Type 1
	2-12. 5	Command Type 2
	2-12. 6	Command Type 3
	2-12. 7	Transmitted only upon completion signal
	2-12. 8	Modbus protocol

Reference 1. Refer to Appendix 2, 3 and 4 for command types.

Menu-F2.13: Set RS-422/485 Port

Function	RS-422/485 Port Setting	
Set Range (0~5)	Display Part	Meaning
	2-13. 0	Data Bit 8, Stop Bit 1, Parity Bit : None
	2-13. 1	Data Bit 7, Stop Bit 1, Parity Bit: Even
	2-13. 2	Data Bit 7, Stop Bit 1, Parity Bit: Odd
	2-13. 3	Data Bit 7, Stop Bit 2, Parity Bit: Odd
	2-13. 4	Data Bit 8, Stop Bit 1, Parity Bit: Even
2-13. 5	Data Bit 8, Stop Bit 1, Parity Bit: Odd	

Menu-F2.14: Set RS-422/485 Baud Rate

Function	RS-422/485 Baud Rate Setting	
Set Range (0~7)	Display Part	Meaning
	2-14. 0	1,200 bps
	2-14. 1	2,400 bps
	2-14. 2	4,800 bps
	2-14. 3	9,600 bps
	2-14. 4	19,200 bps
	2-14. 5	38,400 bps
	2-14. 6	57,600 bps
2-14. 7	115,200 bps	

Menu-F2.15: Set RS-422/485 Out Data

Function	RS-422/485 Out Data Setting	
Set Range (0~2)	Display Part	Meaning
	2-15. 0	Displayed value is transmitted
	2-15. 1	Gross Weight is transmitted
	2-15. 2	Net weight is transmitted

Menu-F2.16: RS-422/485 Output Format

Function	RS-422/485 Output Format	
Set Range (0~3)	Display Part	Meaning
	2-16. 0	22 byte of CAS
	2-16. 1	10 byte of CAS
	2-16. 2	18 byte Format(AND, FINE)
	2-16. 3	22 byte of CAS with relay status

Reference 1. Refer to <Appendix 1> for the communication format

Menu-F2.17: RS-422/485 Communication Method

Function	RS-422/485 Communication Method (Output mode)	
Set Range (0~8)	Display Part	Meaning
	2-17. 0	Data is not transmitted
	2-17. 1	Transmitted only if the print key is pushed
	2-17. 2	Transmitted in both stable/unstable cases (Stream Mode)
	2-17. 3	Transmitted only if the weight is stable
	2-17. 4	Command Type 1
	2-17. 5	Command Type 2
	2-17. 6	Command Type 3
	2-17. 7	Transmitted only upon completion signal
2-17. 8	Modbus protocol	

Reference 1. Refer to Appendix 2, 3 and 4 for command types.

9.4 Analogue Output Setting

Menu-F3.01: A-out activation range setting

Function	Set A-Out range	
Set Range (0, 1)	Display Part	Meaning
	3-01. 0	Unipolar(operating in +weight)
	3-01. 1	Bipolar(operating in \pm weight)

Menu-F3.02: V-out range setting

Function	V-out range	
Set Range (0~4)	Display Part	Meaning
	3-02. 0	V-out is closed
	3-02. 1	0V ~ 5 V
	3-02. 2	0V ~ 10 V
	3-02. 3	\pm 5 V
3-02. 4	\pm 10 V	

Reference 1. Simultaneous output is not used. Therefore the V-out output range settings are applied with priority during setting.

Reference 2. When only using I-out, the V-out output range must be set to 0.

Menu-F3.03: I-out range setting

Function	I-out range	
Set Range (0~3)	Display Part	Meaning
	3-03. 0	I-out is closed
	3-03. 1	4 mA ~ 20 mA
	3-03. 2	0 mA ~ 20 mA
	3-03. 3	0 mA ~ 24 mA

Menu-F3.04: Dual output(V-out & I-out)

Function	Dual output(V-out & I-out)	
Set Range (0, 1)	Display Part	Meaning
	3-04. 0	Dual output disabled
	3-04. 1	Dual output enabled

Menu-F3.05: Minimum weight of A-out

Function	Minimum Output Weight Value upon Using Analog Out option	
Set Range (0~Max weight)	Display Part	Meaning
	1000	Maximum output at 1000 kg
	Initial value : 0	Maximum output at 2000 kg

Menu-F3.06: Maximum weight of A-out

Function	Maximum Output Weight Value upon Using Analog Out option	
	Display Part	Meaning
Set Range (0~Max weight)	1000	Maximum output at 1000 kg Maximum output at 2000 kg
	2000	
	Initial value : Max weight	

Menu-F3.07: Adjust zero of A-out

Function	Adjust the Zero Output upon Using Analog Out option	
	Display Part	Meaning
Set Range (0~24000)	0000	0.000mA, 0V output
	4000	4.000mA, 2V output
	4015	4.015mA, 2.007V output

Reference 1. The example is based on settings of 0~10V, 0~24mA.

Reference 2. The Micro-adjustment function does not work during simultaneous output of V-out and I-out.

Menu-F3.08: Adjust Span of A-out

Function	Adjust the Maximum Output upon Using Analog Out option	
	Display Part	Meaning
Set Range (0~24000)	10000	10.000 mA, 4.16 V output
	20000	20.000 mA, 8.33 V output
	24000	24.000 mA, 10.0 V output

Reference 1. The example is based on settings of 0~10V, 0~24mA.

Reference 2. The Micro-adjustment function does not work during simultaneous output of V-out and I-out.

9.5 Hardware Set Function

Menu-F4.01: Set Date

Function	Set Date	
Number Key	Display Part	Meaning
: Data Designation	10.08.17	August 17th, 2010

Menu-F4.02: Set Time

Function	Set Time	
Number Key	Display Part	Meaning
: Data Designation	11.30.10	30 minutes and 10seconds past 11 o'clock

Menu-F4.03: Set Alibi memory

Function	Set Alibi memory	
Set Range (0, 1)	Display Part	Meaning
	4-03. 0	Alibi memory function is disable
	4-03. 1	Alibi memory function is enable

Menu-F4.04: Set memory over writing

Function	Set memory over writing	
Set Range (0, 1)	Display Part	Meaning
	4-04. 0	Disable over writing of memory
	4-04. 1	Enable over writing of memory

9.6 Relay Setting

Menu-F5.01: Set Relay mode

Function	Set Relay mode	
	Display Part	Meaning
Set Range (0~3)	5-01. 0	Limit Mode
	5-01. 1	Limit type Checker Mode
	5-01. 2	Checker Mode
	5-01. 3	Programmable Mode

<Limit Mode>

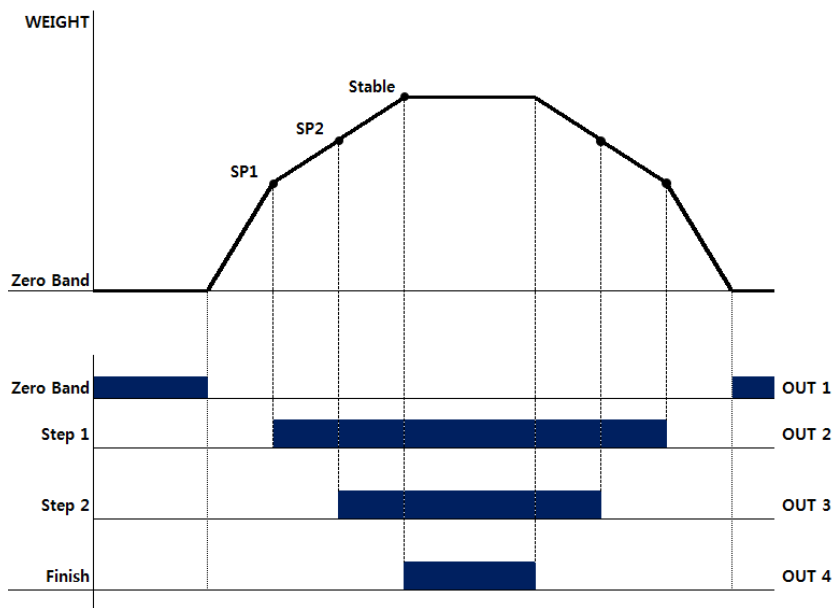

Note.

1. Set value input requirement: $SP2 > SP1$
2. Relay Output

Step 1 : $W \geq SP1 \rightarrow ON$
Step 2 : $W \geq SP2 \rightarrow ON$
Finish : $W \geq SP2 \ \& \ Stable \rightarrow ON$
Near zero : Set value ≥ 0 range output

<Checker Mode>

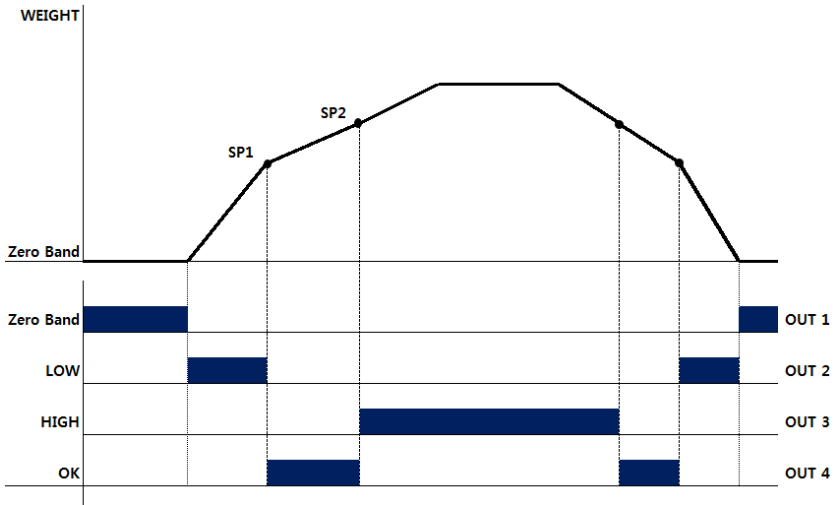

Note.

1. Set value input requirement: $SP2 > SP1$
2. Relay Output

LOW : $SP1 \geq W \rightarrow ON$
HIGH : $W \geq SP2 \rightarrow ON$
Finish(OK) : $SP1 < W < SP2 \rightarrow ON$
Near zero: Set value ≥ 0 range output

<Limit type Checker Mode>

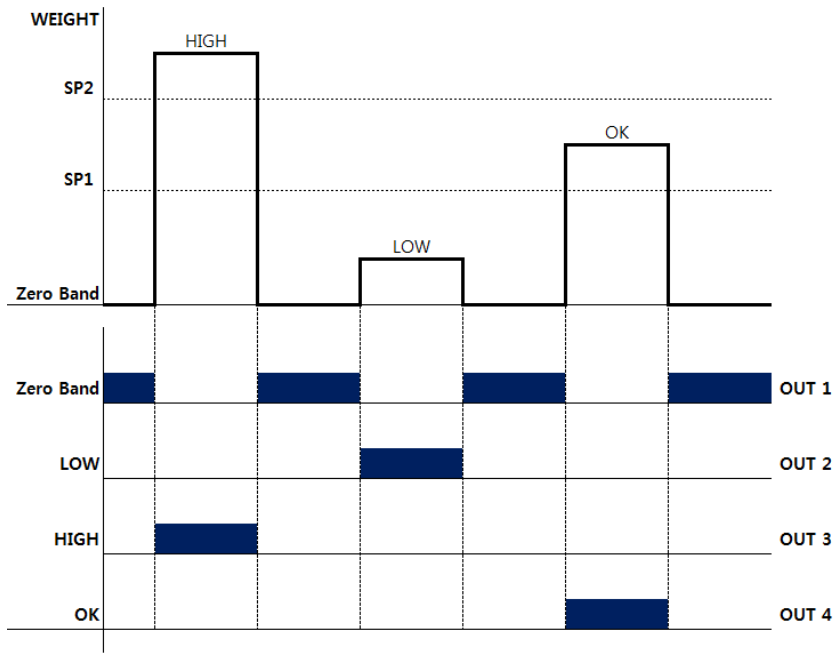

Note.

1. Set value input requirement: $SP2 > SP1$

2. Relay Output

LOW : $SP1 \geq W \rightarrow ON$
HIGH : $W \geq SP2 \rightarrow ON$
Finish(OK) : $SP1 < W < SP2 \rightarrow ON$
Near zero: Set value ≥ 0 range output

3. Whenever stable, each output set.

4. No change the status until come back to the Zero Band

<Programmable Mode>

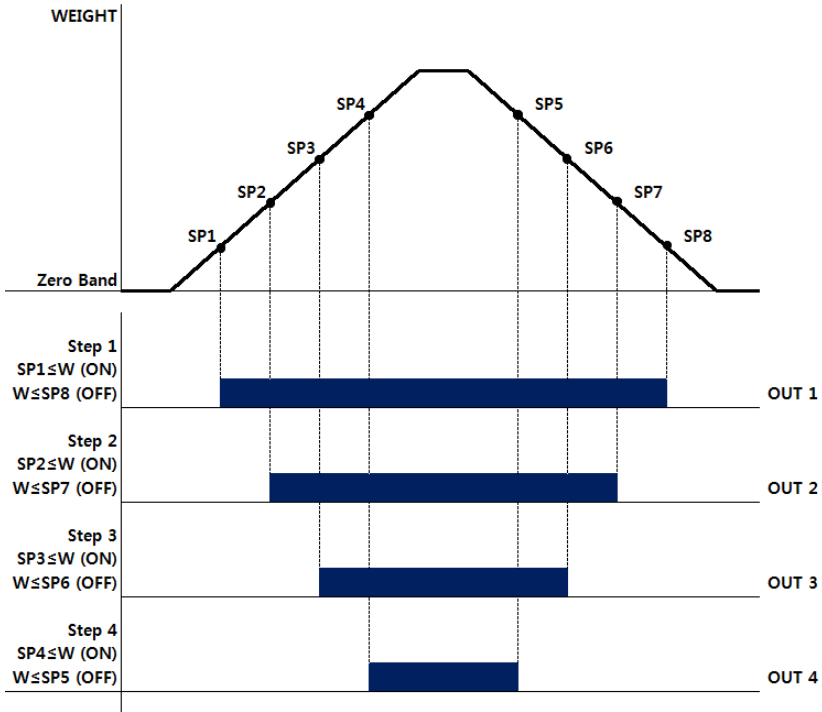

Note.

1. Set value input requirement: $SP4 > SP3 > SP2 > SP1$, $SP5 > SP6 > SP7 > SP8$

2. Relay Output

Step 1 : $W \geq SP1 \rightarrow ON$, $W \leq SP8 \rightarrow OFF$
Step 2 : $W \geq SP2 \rightarrow ON$, $W \leq SP7 \rightarrow OFF$
Step 3 : $W \geq SP3 \rightarrow ON$, $W \leq SP6 \rightarrow OFF$
Step 4 : $W \geq SP4 \rightarrow ON$, $W \leq SP5 \rightarrow OFF$

3. When it increases, External output ON. When it decreases, External output OFF

Relay Mode	OUT 1	OUT 2	OUT 3	OUT 4
□ 1_Limit Mode	Zero	Step 1 $SP1 \leq W$	Step 2 $SP2 \leq W$	Finish(Stable)
□ 2_Limit type Checker Mode	Zero	LOW $W \leq SP1$	HIGH $SP2 \leq W$	Finish(OK) $SP1 < W < SP2$
□ 3_Checker Mode	Zero	LOW $W \leq SP1$	HIGH $SP2 \leq W$	Finish(OK) $SP1 < W < SP2$
□ 4_Programmable Mode	Step 1 $SP1 \leq W$ (ON) $W \leq SP8$ (OFF)	Step 2 $SP2 \leq W$ (ON) $W \leq SP7$ (OFF)	Step 3 $SP3 \leq W$ (ON) $W \leq SP6$ (OFF)	Step 4 $SP4 \leq W$ (ON) $W \leq SP5$ (OFF)

Menu-F5.02: Set Ext Input 1

Function	Set Ext Input 1	
Set Range (0-4)	Display Part	Meaning
	5-02. 00	External In1 is zero key
	5-02. 01	External In1 is tare/tareless key
	5-02. 02	External In1 is print key
	5-02. 03	External In1 is hold key
5-02. 04	External In1 is hold clear key	

Menu-F5.03: Set Ext Input 2

Function	Set Ext Input 2	
Set Range (0-4)	Display Part	Meaning
	5-03. 00	External In2 is zero key
	5-03. 01	External In2 is tare/tareless key
	5-03. 02	External In2 is print key
	5-03. 03	External In2 is hold key
5-03. 04	External In2 is hold clear key	

Menu-F5.04: Relay Reverse On/Off

Function	Relay Reverse On/Off	
Set Range (0, 1)	Display Part	Meaning
	5-04. 00	Relay Reverse OFF
	5-04. 01	Relay Reverse ON

Menu-F5.05: Relay Display On/Off

Function	Relay Display On/Off	
Set Range (0, 1)	Display Part	Meaning
	5-05. 00	Relay Display OFF
	5-05. 01	Relay Display ON

9.7 TCP IP

Menu-F6.01: Set use DHCP

Function	Set use DHCP	
Set Range (0, 1)	Display Part	Meaning
	6-01. 0	Use DHCP
	6-01. 1	Not use DHCP(Static)

Menu-F6.02: Set TCP mode

Function	Set TCP mode	
Set Range (0, 1)	Display Part	Meaning
	6-02. 0	Server mode
	6-02. 1	Client mode

Menu-F6.03: Set EXI-200(Server)IP

Function	Set IP of Server	
Set Range (0~255)	Display Part	Meaning
	I1-XXX	Set IP of 1st position(IP_V4)
	I4-XXX	Set IP of 4th position(IP_V4)
	Initial value : 255	

Menu-F6.04: Set Subnet mask

Function	Set Subnet mask	
Set Range (0~255)	Display Part	Meaning
	M1-XXX	Set subnet mask of 1st position
	M4-XXX	Set subnet mask of 4th position
	Initial value : 255	

Menu-F6.05: Set Gate way

Function	Set Gate way	
Set Range (0~255)	Display Part	Meaning
	G1-XXX	Set gate way of 1st position
	G4-XXX	Set gate way of 4th position
	Initial value : 255	

Menu-F6.06: Set EXI-200(Server) TCP Port

Function	Set EXI-200(Server) TCP Port	
Set Range (0~65535)	Display Part	Meaning
	5000	TCP port number = 5000
	20000	TCP port number = 20000
	Initial value : 20306	

Menu-F6.07: Server TCP Output mode

Function	Server TCP Output mode	
Set Range (0~8)	Display Part	Meaning
	6-07. 0	Data is not transmitted
	6-07. 1	Transmitted only if the print key is pushed
	6-07. 2	Transmitted in both stable/unstable cases (Stream Mode)
	6-07. 3	Transmitted only if the weight is stable
	6-07. 4	Command Type 1
	6-07. 5	Command Type 2
	6-07. 6	Command Type 3
	6-07. 7	Transmitted only upon completion signal
6-07. 8	Modbus protocol	

Reference 1. For command types refer to Appendix 2, 3 and 4.

Reference 2. Communication format =Set values of F2.06 applied.

Menu-F6.08: Set IP of Client

Function	Set IP of Client	
Set Range (0~255)	Display Part	Meaning
	I1-XXX	Set IP of 1st position(IP_V4)
	I4-XXX	Set IP of 4th position(IP_V4)
	Initial value : 255	

Menu-F6.09: TCP port of Client

Function	TCP port of Client	
Set Range (0~99999)	Display Part	Meaning
	5000	TCP port number = 5000
	20000	TCP port number = 20000
	Initial value : 20306	

Menu-F6.10: Client TCP Output mode

Function	Client TCP Output mode	
Set Range (0~8)	Display Part	Meaning
	6-10. 0	Data is not transmitted
	6-10. 1	Transmitted only if the print key is pushed
	6-10. 2	Transmitted in both stable/unstable cases (Stream Mode)
	6-10. 3	Transmitted only if the weight is stable
	6-10. 4	Command Type 1
	6-10. 5	Command Type 2
	6-10. 6	Command Type 3
	6-10. 7	Transmitted only upon completion signal
6-10. 8	Modbus protocol	

Reference 1. For command types refer to Appendix 2, 3 and 4.

Reference 2. Communication format =Set values of F2.06 applied.

9.8 Print Function Setting

Menu-F7.01: Set Printer Type

Function	Set Printer Type	
	Display Part	Meaning
Set Range (0~3)	7-01. 0	Printer is not used
	7-01. 1	CAS DEP Ticket Print Standard Type
	7-01. 2	CAS DLP Label Print Standard Type
	7-01. 3	CAS BP Label Printer

Menu-F7.02: Set Print Form

Function	Set Print Form	
	Display Part	Meaning
Set Range (0~7)	7-02. 0	Print Form 1 (Date, Time, Serial No., Item No., Net Weight) BP Print Form 1(FORM1)
	7-02. 1	Print Form 2 (Date, Time, Weighing No., Net Weight) BP Print Form 2(FORM2)
	7-02. 2	Print Form 3 (Date, Time, Gross Weight, Tare, Net Weight) BP Print Form 3(FORM3)
	7-02. 3	Print Form 4 (Date, Time, Net Weight) BP Print Form 4(FORM4)
	7-02. 4	Print Form 5 (Date, Time, Item No., Net Weight) BP Print Form 5(FORM5)
	7-02. 5	Print Form 6 (Date, Time, Serial No., Net Weight) BP Print Form 6(FORM6)
	7-02. 6	Print Form 7 (Date, Time, Item Name, Item No., Net Weight) BP Print Form 7(FORM7)
	7-02. 7	Print Form 6 (Date, Time, Item Name, Net Weight) BP Print Form 8(FORM8)

【 Form 1 】
 Date, Time,
 Serial No., Item No., Net
 Weight

2009.07.07[TUE]	12:30:46
1, ID_11,	50.0 kg
2, ID_12,	100.0 kg
3, ID_19,	200.5 kg

【 Form 2 】
 Date, Time,
 Weighing No., Net Weight

2009.07.07[TUE]	12:30:46
No. 1	50.0 kg
No. 2	100.0 kg
No. 3	200.5 kg

【 Form 3 】
 Date, Time,
 Gross Weight, Tare, Net
 Weight

2009.07.07[TUE]	12:30:46
Gross :	1000.0 kg
Tare :	0.0 kg
Net :	1000.0 kg
Gross :	2000.0 kg
Tare :	500.0 kg
Net :	1500.0 kg

【 Form 4 】
 Date, Time,
 Net Weight

2009.07.07[TUE]	12:30:46
10:10:30	Net: 50.0 kg
11:00:32	Net: 100.0 kg
12:30:34	Net: 200.5 kg

【 Form 5 】
 Date, Time,
 Item No., Net Weight

2009.07.07[TUE]	12:30:46
ID_11, Net:	50.0 kg
ID_12, Net:	100.0 kg
ID_19, Net:	200.5 kg

【 Form 6 】
 Date, Time,
 Serial No., Net Weight

2009.07.07[TUE]	12:30:46
1,	1000.0 kg
2009.07.07[TUE]	12:32:56
2,	200.5 kg

【 Form 7 】
 Date, Time,
 Item Name
 Item No., Net Weight

2009.07.07[TUE]	12:30:46
Cement	
ID_11, Net:	50.0 kg
Cement	
ID_11, Net:	50.0 kg

【 Form 8 】
 Date, Time,
 Item Name., Net Weight

2009.07.07[TUE]	12:30:46
Cement	50.0 kg
2009.07.07[TUE]	12:30:46
Cement	150.0 kg

CAS DLP Protocol

Parameter	Description	Data Length
V00	Gross Weight	7 byte
V01	Tare Value	7 byte
V02	Net Weight	7 byte
V03	Barcode (net weight)	6 byte
V04	Item Number	2 byte
V05	Item Name	10 byte
V06	Print count	3 byte
V07	Date	10 byte
V08	Time	8 byte

CAS BP Series Printer Protocol

Parameter	Description	Data Length
V00	Gross Weight	7 byte
V01	Tare Value	7 byte
V02	Net Weight	7 byte
V03	Net ('.' omit) : for bar code	6 byte
V04	Item Number	2 byte
V05	Item Name	10 byte
V06	Print count	3 byte
V07	Date	10 byte
V08	Time	8 byte
V09	Unit(kg)	2 byte
V10	Total Net ('.' include)	9 byte
V11	Preset Tare	7 byte

Menu-F7.03: Manage Print Data

Function	Manage Print Data	
Set Range (0~1)	Display Part	Meaning
	7-03. 0	Accumulated value is cleared upon printing
	7-03. 1	Cleared when the clearing key is pushed

Menu-F7.04: Set Print Line feed

Function	Set Print Line feed	
Set Range (0~9)	Display Part	Meaning
	7-04. 1	Set a spacing between lines as the set value upon printing
	Initial Value: 1	

Menu-F7.05: Set Print Head Message

Function	Set Print Head Message	
Set Range (32~255)	Display Part	Meaning
	12 - 065	Designate a character "A" equivalent to ASCII code 65 in the 12th data
	00 - 032	To print out the added contents, designate ASCII code 32 to 0th data.
	18 - 255	The end has to be meant by designating ASCII code 255 next to the last data.

 : number settings,
  : coordinate increase,

 : coordinate decrease,
  : input complete

Reference 1. This function adds the desired content to the print format. (e.g.: company name, phone number)

Reference 2. Coordinates capable of being designated are from 0 to 71. From these, the 0th data determines whether to print the additional content (032: print, all others: do not print) and everything is printed from data 1 until data 255.

Reference 3. To add company name "CAS" to the existing print format, designate as follows

P00-032 (ASCII code 32: data starts),
 P01-067 (ASCII code 67: character C)
 P02-065 (ASCII code 65: character A)
 P03-083 (ASCII code 83: character S)
 P04-255 (ASCII code 255: data ends)

Menu-F7.06: Set Printing Delay Time

Function	Set Printing Delay Time	
Set Range (0~200)	Display Part	Meaning
	7-06. 1	Issue print after 00 x 10ms
	Initial Value: 1	

Menu-F7.07: Set Print Condition

Function	Set Print Condition	
Set Range (0~2)	Display Part	Meaning
	7-07. 0	Print out only if the weight value is +
	7-07. 1	Print out only if the weight value is -
	7-07. 2	Print out regardless of whether the weight value is +/-

Menu-F7.08: Set Print Out Condition

Function	Set Print Out Condition (Printing condition)	
Set Range (0~1)	Display Part	Meaning
	7-08. 0	Printed only if the print key is pushed
	7-08. 1	Printed automatically if the weight value is stabilized

Menu-F7.09: Print Count Number

Function	Print Count Number	
Set Range (0~1)	Display Part	Meaning
	7-09. 0	Fixed
	7-09. 1	Printing times are increased automatically by one at a time after weighing operation

10. Error Message

10.1 Errors that can occur in weight calibration mode

Error	Cause	Solution
Err 20	The set resolution has exceeded the allowance limit of 1/30,000.	Lower resolution. Resolution = maximum allowed weight/value of 1 increment. Adjust maximum allowed weight in CAL 1 of weight calibration mode or adjust the value of 1 increment in CAL 3 of weight calibration mode to adjust to below 1/30,000.
Err 22	The counterweight for span adjustment has been set to less than 10% of maximum weighing scale capacity.	Set the counterweight weight as greater than 10% of the maximum scale capacity (set in CAL 1) in CAL 4 of weight calibration mode.
Err 23	The counterweight for span adjustment has been set to exceed 100% of the weighing scale capacity.	Set the counterweight weight to within the maximum weighing scale capacity (set in CAL 1) in CAL 4 of weight calibration mode.
Err 24	Span is too low.	Setting the present resolution is not possible as there is an issue with the load cell or the load cell output is too small. Reset the weight calibration by reducing the resolution. PCS, PERCENT Sample weight is too small
Err 25	Span is too high.	There is an issue with the load cell or the load cell output is too high. Redo steps from weight setting CAL 4 zero-set adjustment. PCS, PERCENT Sample weight is too great.
Err 26	Zero-set is too high.	Check if the load plate of the weighing scale is clear. After verifying in Test Mode 3, redo the weight calibration.
Err 27	Zero-set is too low.	After checking the force applied to the weighing scale load plate in Test Mode 3, redo the weight calibration.
Err 28	Weight is unstable.	Check if the load cell connector is properly connected.

10.2 Errors that can occur in weighing mode

Error	Cause	Solution
Err 01	Due to unstable load the weighing scale cannot be reset.	Move the weighing scale to a flat, vibration-free surface and turn on the power.
Err 02	Load cell is not properly connected or there is a problem with the A/D convertor.	Check if the main body and the load plate are connected properly.
Err 08	The zero-set key, container key and start key are set not to function when the load is unstable.	In F22 of the Conversion Mode, set the zero-set key, container key and start key activation conditions based on the environment of use.
Err 09	The current weight exceeds the zero-set range.	In F09 of Conversion Mode set the activation range to within 2% or 10% of the maximum capacity.
Err 10	The weight of the container being designated exceeds the maximum capacity of the weighing scale.	Set the container weight to be less than the maximum capacity.
Err 13	When calibrating the weight the set zero-set has been exceeded.	Check the status of the load plate and redo the weight calibrations.
Err 15	In Command Mode, the Item Code has exceeded the set range.	Check the Item Code range
Err 82	There is a problem with the A/D convertor.	Please contact the A/S center.
OVER	The current load on the load plate is too heavy, and exceeds the allowance limit.	Do not place weight exceeding the capacity limit on the weighing scale. If the load cell is damaged, it must be replaced.

*Weight Date (8 byte)

Example weight	Byte No							
	1	2	3	4	5	6	7	8
13.5kg	“	“	“	“	‘1’	‘3’	‘.’	‘5’
135kg	“	“	“	“	‘1’	‘3’	‘5’	“
-135kg	‘-’	“	“	“	‘1’	‘3’	‘5’	“

Appendix 2> Command Mode 1 Description

CAS <NT-500 Command>

Indicator Reception	Function	Indicator Response
dd RW CR LF	Request for Weight Data	Transmit the data in the set format upon command input
dd MZ CR LF	Same as Zero Key	Execute the zero and retransmit dd MZ CR LF to PC upon command input
dd MT CR LF	Same as Tare Key	Execute tare and retransmit dd MT CR LF to PC upon command input
dd PN 00 CR LF	Input Item No.(00~50)	Change the item no. and retransmit dd PN 00 CR LF to PC upon command input.
dd OP CR LF	Same as Start Key	Execute the start and retransmit dd OP CR LF to PC upon command input
dd EM CR LF	Same as Stop Key	Execute the stop and retransmit dd EM CR LF to PC upon command input

* dd : Device ID. (ASCII Code : 0×30(hex), 0×31(hex if the Device ID is “01”)

* 00000,00 : Set value for upper limit/lower limit/upper limit fall/lower limit fall

(ASCII Code : 0x30(hex), 0x30(hex), 0x33(hex), 0x34(hex),

0x35(hex) if the set value is “00345”)

* When it fails to execute the command : ! CR LF is transmitted to the computer.

* When there is an error in the command : ? CR LF is transmitted to the computer.

Appendix 3> Command Mode 2 Description

CAS <NT-570 Command>

Reference 1. Command Mode Table

Command data to NT-570A											Command description	NT-570A Respond	
0	1	2	3	4	5	6	7	8	9	10			11
D	ID	K	Z	CR	LF							ZERO key	
D	ID	K	T	CR	LF							TARE key	Return the received
D	ID	K	G	CR	LF							GROSS key	Return the received
D	ID	K	N	CR	LF							NET key	Return the received
D	ID	K	S	CR	LF							START key	Return the received
D	ID	K	P	CR	LF							STOP key	Return the received
D	ID	K	B	CR	LF							Print key	Return the received
D	ID	K	C	CR	LF							Total print key	Return the received
D	ID	K	W	CR	LF							Request weight data	Return the received
D	ID	H	T	CR	LF							Request set point value	Send Format 2
D	ID	S	1	0	0	0	0	0	0	CR	LF	1 st Step value	Return the received
D	ID	S	2	0	0	0	0	0	0	CR	LF	2nd Step value	Return the received
D	ID	S	3	0	0	0	0	0	0	CR	LF	3rd Step value	Return the received
D	ID	S	4	0	0	0	0	0	0	CR	LF	4th Step value	Return the received
D	ID	S	5	0	0	0	0	0	0	CR	LF	High limit value	Return the received
D	ID	S	6	0	0	0	0	0	0	CR	LF	Low limit value	Return the received
D	ID	H	E	0	0	0	0	0	0	CR	LF	Set point code(00-99)	Return the received

(D, ID:00-99, CR : 0×13, LF: 0×10)

* Format 1 : PC send set point all data to indicator NT-580A

0	1	2	3	4	5	6	7	8	9	10	11	12	13	14	15	16	17	18	19		
D	ID	H	A	Set Point code						,	SP	SP	SP	SP	SP	SP	„	Optional-			
20	21	22	23	24	25	26	27	28	29	30	31	32	33	34	35	36	37	38	39		
			Preliminary					,	Final value					,	Free Fall						
40	41	42	43	44	45	46	47	48	49	50	51	52	53								
,	High limit					,	Low limit					CR	LF								

* Format 2 : Recieve the request data from PC then response of Indicator

0	1	2	3	4	5	6	7	8	9	10	11	12	13	14	15	16	17	18	19		
D	ID	H	T	Set Point code						,	SP	SP	SP	SP	SP	SP	„	Optional-			
20	21	22	23	24	25	26	27	28	29	30	31	32	33	34	35	36	37	38	39		
			Preliminary					,	Final value					,	Free Fall						
40	41	42	43	44	45	46	47	48	49	50	51	52	53								
,	High limit					,	Low limit					CR	LF								

* Please input without the decimal point.

Appendix 4> Command mode 3 Description
CI-5000 : Transmission only if data is requested (1 byte communication)

Appendix 5> ASCII Table

CHA	CODE	CHA	CODE	CHA	CODE	CHA	CODE	CHA	CODE	CHA	CODE
Space	32	0	48	@	64	P	80	`	96	p	112
!	33	1	49	A	65	Q	81	a	97	q	113
“	34	2	50	B	66	R	82	b	98	r	114
#	35	3	51	C	67	S	83	c	99	s	115
\$	36	4	52	D	68	T	84	d	100	t	116
%	37	5	53	E	69	U	85	e	101	u	117
&	38	6	54	F	70	V	86	f	102	v	118
‘	39	7	55	G	71	W	87	g	103	w	119
(40	8	56	H	72	X	88	h	104	x	120
)	41	9	57	I	73	Y	89	i	105	y	121
*	42	:	58	J	74	Z	90	j	106	z	122
+	43	;	59	K	75	[91	k	107	{	123
,	44	<	60	L	76	\	92	l	108		124
-	45	=	61	M	77]	93	m	109	}	125
.	46	>	62	N	78	^	94	n	110	~	126
/	47	?	63	O	79	_	95	o	111	End	0

Appendix 6>MODBUS-RTU PROTOCOL

The registry read and write shown below of MODBUS-RTU protocol can be managed based on the requirements included in the reference document regarding the **Modicon PI-MBUS-300** standard.

For selection of communication with Modbus-RTU, the serial communication settings paragraph has been included.

If specific data has been recorded directly in EEPROM type memory, it is recommended that unnecessary work at the aforementioned position be avoided as the memory is limited in its write activation (100,000).

The below number is, when coming after 0x, is described in a decimal or a hexadecimal method.

MODBUS-RTU DATA FORMAT

Data transferred by the Modbus-RTU protocol has the following characteristics.

- Start bit 1
- Data bit 8 (smallest bit sent first)
- Parity bit setting (instrument setting)
- Stop bit setting (instrument setting)

MODBUS SUPPORTED FUNCTIONS

From the commands capable of being used in the Modbus-RTU protocol, only the following are used in communication management with the instrument. Other commands may not be accurately interpreted and may cause error or shutdown the system.

Function	Explanation
03(0x03)	READ HOLDING REGISTER
16(0x10)	PRESET MULTIPLE REGISTERS

The request cycle is integrated with the preset communication speed. (The instrument requires a transfer delay of at least 3 bytes to reply to the request)

Delay parameters exist in the serial communication setting, and directly affect the number of request possible in a unit time by additionally delaying the reply from the instrument.

For additional information about this protocol, refer to the PI_MBUS_300 normal technical specifications.

Typically, the request and reply for the slave instrument is composed as follows.

FUNCTION 3: Read holding registers

Request

Address	Funcion	Register1 Address	No. register	2 bytes
A	0x03	0x0000	0x0002	CRC

Total. bytes = 8

Reply

Address	Funcion	No.bytes	Register1	Register2	2 bytes
A	0x03	0x04	0x0064	0x00C8	CRC

Total. bytes = 3 + 2*No. register + 2

-number of register = number of modbus register to be read, start at address 1 register.

-number of byte = number of bytes in the following data

FUNCTION 16: Preset multiple registers

Request

Addr	Funcion	Add. Reg.1	No.reg.	No. bytes	Val. Reg. 1	Val. Reg. 2	2 bytes
A	0x10	0x0000	0x0002	0x4	0x0000	0x0000	CRC

Total. bytes = 7 + 2*No. register + 2

Reply

Address	Funcion	Add.Reg.1	No.reg.	2 bytes
A	0x10	0x0000	0x0002	CRC

Total. bytes = 8

-No. registers = number of modbus register to be read, start at address 1 register

-No. bytes = Number of following data bytes

-Val.reg.1 = Content of starting register

In the reply, the number of converted redcodes starting from address 1 is included.

Communication Error Management

The management of communication data error must be controlled by CRC (cycle redundancy check).

If a communication error occurs, the slave does not reply to any request.

The master must consider the time-out before receiving the reply. If no reply is received, it can be inferred that a communication error has occurred.

If the data strings have been accurately received but cannot be executed, an exceptional response is required. The contents are as follows.

Exceptional response

Address	Function	Code	2bytes
A	Func + 0x80		CRC

CODE	DESCRIPTION
1	Invalid or unsupported function (ILLEGAL FUNCTION)
2	When the stated data address cannot be used (ILLEGAL DATA ADDRESS)
3	When the received data value is invalid (ILLEGAL DATA VALUE)
4	Error in the CRC code (CRC Error)

Register List

The Modbus-RTU protocol registers capable of being executed in this instrument are as follows.

R = Register that can be used as read-only

W = Register that can be used as write-only

R/W = Register that can be used as for both read and write

H = Higher word of the Double word composing the register

L = Lower word of the Double word composing the register

REGISTER	DESCRIPTION	Input value	Saving to EEPROM	ACCESS
40002	Type of instrument	-	-	R
40008	GROSS WEIGHT H	-	-	R
40009	GROSS WEIGHT L	-	-	R
40010	NET WEIGHT H	-	-	R
40011	NET WEIGHT L	-	-	R
40014	Raw AD Data_H	-	-	R
40015	Raw AD Data_L	-	-	R
40017	Set point 1 H	0~99999	Y	R/W
40018	Set point 1 L	0~99999	Y	R/W
40019	Set point 2 H	0~99999	Y	R/W
40020	Set point 2 L	0~99999	Y	R/W
40021	Set point 3 H	0~99999	Y	R/W
40022	Set point 3 L	0~99999	Y	R/W
40023	Set point 4 H	0~99999	Y	R/W
40024	Set point 4 L	0~99999	Y	R/W
40037	Ext_Input	-	-	R/W

40038	Ext_Output	-	-	R/W
40042	Analog out Span Weight H	0~99999	Y	R/W
40043	Analog out Span Weight L	0~99999	Y	R/W
40044	Analog out Zero Adjust H	0~99999	Y	R/W
40045	Analog out Zero Adjust L	0~99999	Y	R/W
40046	Analog out Span Adjust H	0~99999	Y	R/W
40047	Analog out Span Adjust L	0~99999	Y	R/W
40050	Analog Out V-Out range Setting	0~99999		
40051	Analog Out I-Out range Setting	0~99999		
40052	Analog Out Dual-Out range Setting	0~99999		
40060	ADC Speed	0~99999	Y	R/W
40062	AD Filter Size	0~99999	Y	R/W
40063	Set Low pass filter	0 : OFF 1 : ON	Y	R/W
40064	Order of Low pass filter	2~4	Y	R/W
40065	Cut frequency of Low pass filter	1~100	Y	R/W
40066	Set Band stop filter	0 : OFF 1 : ON	Y	R/W
40067	High cut Frequency of Band stop filter	1~100	Y	R/W
40068	Low cut Frequency of Band stop filter	1~100	Y	R/W
40069 ~ 40080	Reserved		-	-
40053	Ext_Input		Y	R/W
40060	Ext_Output		Y	R/W
40062	Analog out Span Weight H		Y	R/W
40063	ADC reserved		-	-
40064	ADC reserved		-	-
40065	ADC reserved		-	-

40066	ADC reserved		-	-
40067	ADC reserved		-	-
40068	ADC reserved		-	-
40081	Stable range	0~99	Y	R/W
40082	Zero tracking range	0~9	Y	R/W
40083	Weight back up	0 : OFF 1 : ON	Y	R/W
40084	Zero key range	0~99	Y	R/W
40085	Tare key range	0~99	Y	R/W
40086	Initial zero range	0~99	Y	R/W
40087	Overload range	0~9	Y	R/W
40088	reserved		-	-
40089	Zero, Tare, Gross/Net, Hold, Tare Clear, Hold Clear	1 : Zero 2 : Tare 3 : Gross/Net 4 : Hold 5 : Tare Clear 6 : Hold Clear	Y	W
40090	reserved		-	-
40151	Device Number		Y	R/W
40152	Comm transmit time		Y	R/W
40153	COM1's parity bit		Y	R/W
40154	COM1's Baudrate		Y	R/W
40155	COM1's output data(Gross/Net)		Y	R/W
40156	COM1's output format		Y	R/W
40157	COM1's output mode		Y	R/W
40158 ~ 40170	reserved		-	-
40171	Set Year		Y	R/W
40172	Set Month		Y	R/W

40173	Set Date		Y	R/W
40174	Set Hour		Y	R/W
40175	Set Minute		Y	R/W
40176	Set Second		Y	R/W
40177	Set use Alibi memory		Y	R/W
40178 ~ 40199	reserved		-	-
40200	Local IP1 (000. XXX. XXX. XXX)	0~255	Y	R/W
40201	Local IP2 (XXX. 000. XXX. XXX)	0~255	Y	R/W
40202	Local IP3 (XXX. XXX. 000. XXX)	0~255	Y	R/W
40203	Local IP4 (XXX. XXX. XXX. 000)	0~255	Y	R/W
40204	Server IP1 (000. XXX. XXX. XXX)	0~255	Y	R/W
40205	Server IP2 (XXX. 000. XXX. XXX)	0~255	Y	R/W
40206	Server IP3 (XXX. XXX. 000. XXX)	0~255	Y	R/W
40207	Server IP4 (XXX. XXX. XXX. 000)	0~255	Y	R/W
40208	Sub net mask1 (000. XXX. XXX. XXX)	0~255	Y	R/W
40209	Sub net mask2 (XXX. 000. XXX. XXX)	0~255	Y	R/W
40210	Sub net mask3 (XXX. XXX. 000. XXX)	0~255	Y	R/W
40211	Sub net mask4 (XXX. XXX. XXX. 000)	0~255	Y	R/W
40212	Gate way1 (000. XXX. XXX. XXX)	0~255	Y	R/W
40213	Gate way2 (XXX. 000. XXX. XXX)	0~255	Y	R/W

40214	Gate way3 (XXX. XXX. 000. XXX)	0~255	Y	R/W
40215	Gate way4 (XXX. XXX. XXX. 000)	0~255	Y	R/W
40216	Set DHCP	0 : OFF 1: ON	Y	R/W
40217	Set TCP/IP Mode (Server mode, Client mode)	0 : Server 1: Client	Y	R/W
40218	Set Local Port Number	0~65535	Y	R/W
40219	Set Server Port Number	0~65535	Y	R/W
40220	Set Local Comm mode	0~7	Y	R/W
40221	Set Server Comm mode	0~7	Y	R/W

MEMO



MEMO

EXI-200AD

Explosion proof Indicator



CAS BLDG., #1315, YANGJAE-DAERO,
GANGDONG-GU, SEOUL, KOREA

TEL_ 82 2 2225 3500

FAX_ 82 2 475 4668

www.globalcas.com